



Reti brembo s.r.l.



safety nets and collective protection equipment

reti di sicurezza anticaduta e dispositivi di protezione collettiva

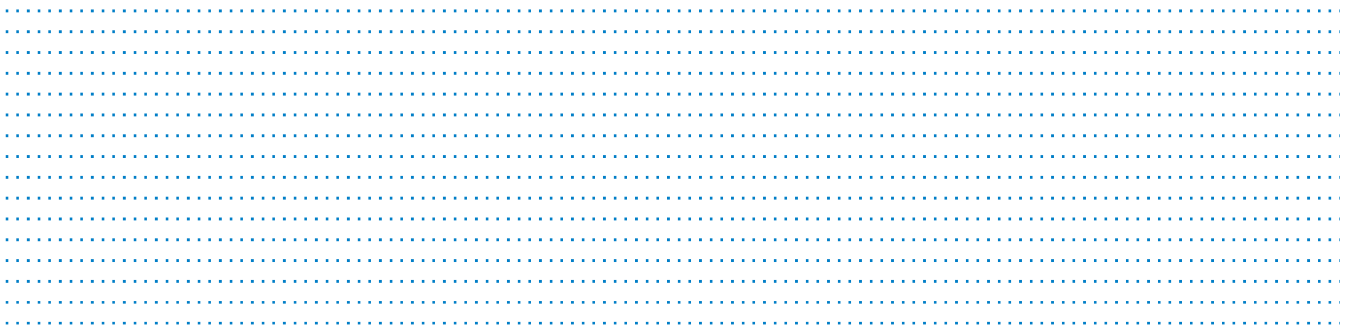



More than nets.





Our mission

To provide our customers with quality and reliability in safety net systems solutions through a personalised and complete service in product, advice and training.

La nostra missione

Fornire ai nostri clienti qualità e affidabilità nel campo dei sistemi di reti di sicurezza anticaduta mediante un servizio personalizzato e integrale che comprende prodotto, consulenza e formazione.

Our vision

To contribute with the structure and technology needed to increase customer satisfaction both in sale and after-sale areas, so that in the near future the brand Reti Brembo remains associated in our customers' mind as symbol of quality and competence in its sector.

La nostra visione

Offrire la struttura e la tecnologia necessarie per aumentare la soddisfazione del cliente, sia nell'area delle vendite che in quella del post-vendita, affinché in un futuro prossimo il cliente associ il marchio Reti Brembo ad un simbolo di qualità e competenza del settore.

The company

Reti Brembo is born as result of the alliance of a group of enthusiastic professionals with the motivation of bringing to life a new project with renewed ideas.

L'azienda

Reti Brembo è il risultato di una collaborazione tra appassionati professionisti con la motivazione di dar vita ad un nuovo progetto con idee nuove.

A young but experienced team

We are a young company, and therefore willing to work hard and with enthusiasm innovating systems and developing new products in an efficient and sustainable manner. However, we also have different and noticeable experiences in this sector that allow us to take decisions with criteria and have the training needed to know and support our customers.

Un gruppo giovane e con esperienza

Siamo un'azienda giovane, e quindi desiderosa di lavorare con forza ed entusiasmo all'innovazione dei sistemi e allo sviluppo di nuovi progetti in modo efficiente e sostenibile. Tuttavia, abbiamo fatto anche esperienze diverse e straordinarie nel settore che ci consentono di prendere decisioni consapevoli e di avere a disposizione la preparazione necessaria per conoscere e offrire sostegno ai nostri clienti.

Multi-disciplined

The Reti Brembo team is formed by a wide spectrum of professionals. We count with net craftsmen, skillful welders, marketing specialists and engineers; each one contributing with its attributes and characteristics to help the company offers high level solutions.

Multidisciplinare

Il team di Reti Brembo è composto da un ampio ventaglio di professionisti. Disponiamo di esperti di reti con grandi capacità artigianali, qualificati saldatori, specialisti di marketing e ingegneri; ognuno dà il suo contributo con le sue qualità e le proprie caratteristiche all'azienda offrendo soluzioni di alto livello.

A family company

At Reti brengo we consider ourselves a family. We count on each other, and we look towards giving the maximum from each of us, as well as we expect it from our team mates. This way, we manage to construct a strong and solid team that works for the same aims, capable of offering a much customized service to each customer.

Un'azienda familiare

In Reti Brengo ci consideriamo una famiglia. Ci sosteniamo a vicenda e cerchiamo di dare il massimo nello stesso modo in cui ce lo aspettiamo dai nostri colleghi. In questo modo siamo riusciti a costruire un team forte e solido che lavora con gli stessi obiettivi, in grado di offrire un servizio altamente personalizzato a ciascun cliente.

R+D+I

In the pursuit of excellence, we are constantly searching and incorporating new methods and production systems that can provide us with better results and efficiency.

Reti Brengo operates worldwide, therefore our reach has no frontiers, and proof of that is our modern machinery brought from different continents.

The binomial (R+D+I) + craftsmanship grant our product and services with supreme quality.

Ricerca, Sviluppo e Innovazione

Per raggiungere l'eccellenza, siamo costantemente alla ricerca di nuovi metodi e sistemi di produzione che ci forniscano risultati migliori e migliore efficienza. Reti Brengo opera a livello mondiale, quindi il nostro ambito d'azione non ha confini e la prova di ciò sono le nostre macchine moderne provenienti da vari continenti.

La combinazione di Ricerca, Sviluppo e Innovazione conferisce ai nostri prodotti e ai nostri servizi una qualità suprema.



Reti brengo s.r.l.

by
Visonets
Italia

VALUES VALORI

Made in Italy

Our production system is based on the binomial technology + craftsmanship. We combine the latest technologies with traditional crafting techniques in the manufacturing of nets and metal structures.

Made in Italy

Il nostro sistema di produzione si basa sulla combinazione tecnologia + artigianato. Uniamo mezzi tecnologici di ultima generazione a tecniche artigianali tradizionali nella produzione di reti e strutture metalliche.

Custom service

Reliability in our work is what certifies and credits us, as well as shows us the path to keep progressing. We take each customer as an opportunity to demonstrate that the quality we presume to have in our service is more than justified.

Servizio personalizzato

L'affidabilità nel nostro lavoro ci supporta e ci accredita, oltre a indicarci la strada per continuare a crescere. Vediamo ogni cliente come un'opportunità per dimostrare che la qualità di cui siamo orgogliosi è più che giustificata.

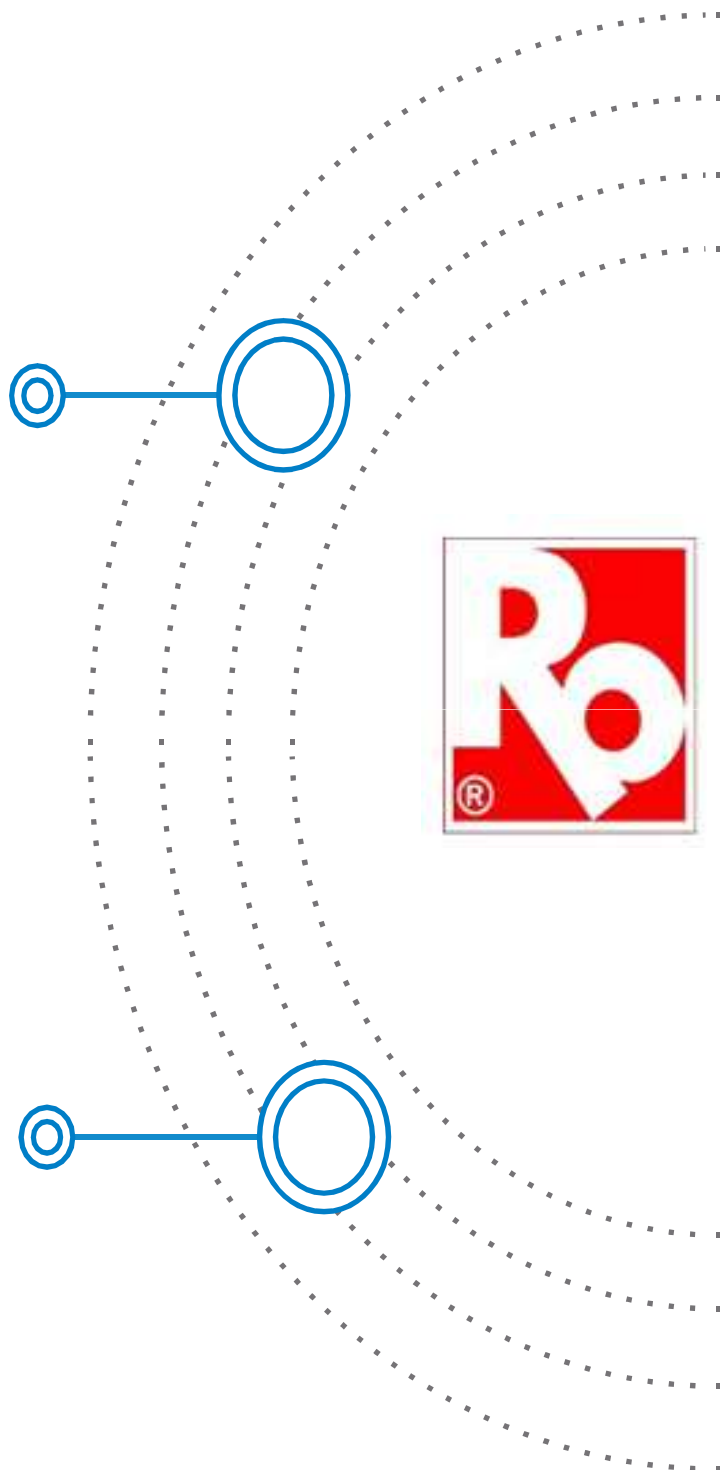

Net and collective protection equipment design

We design our products to our customer's needs, with the aid of 3D software in order to obtain better results.

Progettazione di reti e dispositivi di protezione collettiva

Progettiamo e adattiamo i nostri prodotti su misura per il cliente, con l'aiuto di strumenti 3D per ottenere sempre i migliori risultati.

Advice and training

We are manufacturers and specialists, and that's why we believe there is no one better than us to explain the details and uses of our products. We offer a direct advice service, as well as training courses all around the world, in different languages.

Consulenza e formazione

Siamo produttori e specialisti, ed è per questo che crediamo che non ci sia nessuno migliore di noi per spiegare i dettagli e le applicazioni dei nostri prodotti. Offriamo supporto diretto dalla fabbrica, e anche corsi di formazione in tutto il mondo e in diverse lingue.

Reti brembo s.r.l.

by
Visonets
Italia



Reti brembo s.r.l.

by
Visonets
Italia

QUALITY QUALITÀ

Our engineering and quality department makes a daily effort in order to offer simpler but effective systems. We firmly support an R+D+I philosophy, and that makes us feel proud and differentiated.

As evidence of this, the efforts of Reti Brembo team result in our certified products such as:

A riprova di ciò, gli sforzi del team di Reti Brembo si riflettono nei nostri certificati di prodotto come ad esempio:



Being also proudly members of:
Siamo anche membri orgogliosi di:



Il nostro dipartimento di ingegneria e qualità si impegna quotidianamente per offrire sistemi sempre più semplici ma più efficienti. Scommettiamo molto fortemente su una filosofia basata su Ricerca, Sviluppo e Innovazione e questo ci rende orgogliosi e unici.

And countless tests conducted by qualified laboratories:

E innumerevoli test condotti da laboratori qualificati:

FUNDACIÓN LABORAL DE LA CONSTRUCCIÓN

STATEMENT OF CONFORMITY ASSESSMENT

Applicant: VISOR FALL ARREST NETS S.L.
Product: Safety Net system T (nets attached on brackets for horizontal use)
Assessment Entity: Fundación Laboral de la Construcción
Entity: Assessment Center about Collective Protection Systems against Falling Height

The Assessment Center about Collective Protection Systems, such as **competent laboratory**, for its test on the safety nets in accordance with the standard **EN 1263-1**, declares that:

- The next model of safety net system T, designed and manufactured by Visor Fall Arrest Nets S.L., with the characteristics and configuration described below:

Configuration	Characteristics
A (Impact between brackets)	Anchorage System: Clamp with mechanical anchors introduced in concrete. The clamp is composed by different structural steel profiles of square section 40x60x3mm and 50x50x3mm.
	Metallic Elements: The anchors used are a mechanical bolts Ø10x70mm (quality steel 6.8)
	Horizontal tubes: Aluminium tubes of 6000mm length and section 50x50x3mm.
	Diagonal: Aluminium tubes of 4500mm length and section Ø55x5mm.
	Vertical support: Steel profile of 3000mm length and section 50x50x3mm.
B (Impact above supporting framework)	Textile Elements: Net with mesh size Q60, manufactured with polypropylene high tenacity without knots.
	Rope: Border rope type W (minimum tensile 20kN)
the textile and metallic components are similar than the sample for the configuration A.	
Length:	1200mm
Overlapped area:	Coupling rope: rope denomination type Ø (minimum tensile 7.5kN)





Image 1. Configuration Test A (Impact on the centre of the net between two brackets)
 Image 2. Configuration Test B (Impact above one supporting framework)

Has been passed satisfactorily the dynamic strength test of safety net system T, in accordance with section 7.10 of standard EN 1263-1:2014.

In Madrid on May 7, 2019



Carlos Lozano Martinez,
 Technical Responsible of Assessment Center about Collective Protection Systems against Falling Height



Traceability / Tracciabilità

Our nets count with all the elements needed in order to have a complete traceability at all time.

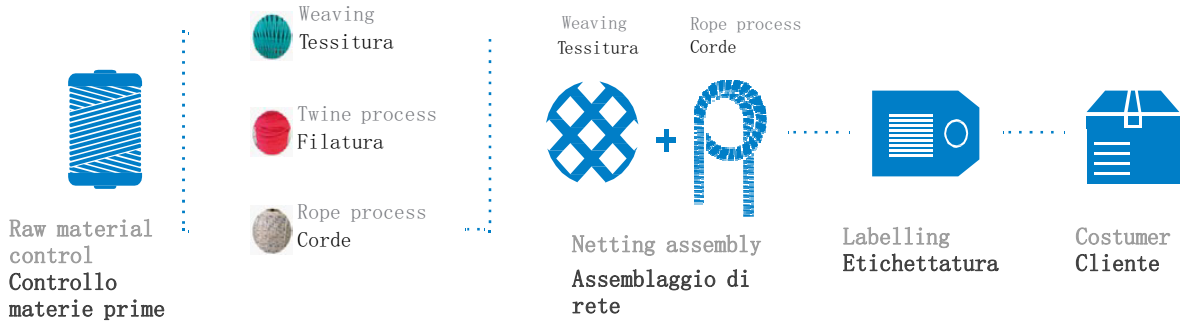
Le nostre reti dispongono di tutti gli elementi necessari affinché la tracciabilità sia completa in ogni momento.



Labelling / Etichettatura

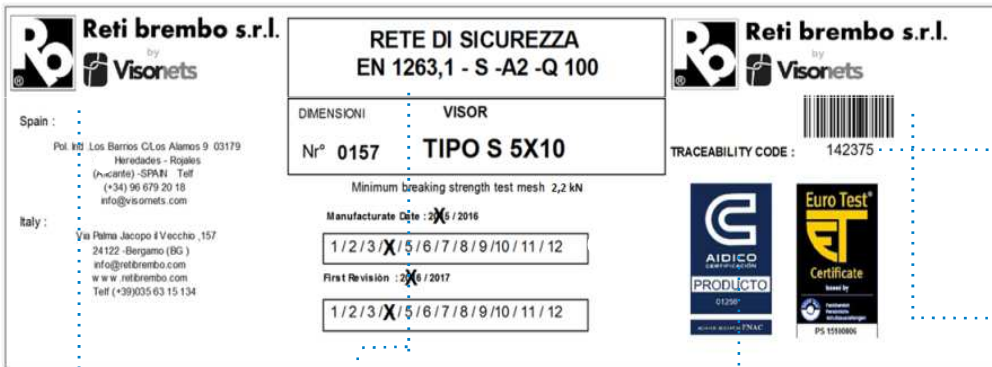

Printed traceability code

Codice di tracciabilità stampato

Bar code
Codice a barre

Reti Brembo brand
Marchio Reti Brembo

Description according to standards
Denominazione secondo gli standard

Quality certifications
Certificati di qualità

Stitched on to the selvage
Cucita sul bordo



Label reinforced with nylon cables

Etichetta rinforzata con fascette di nylon



QUALITY QUALITÀ

Test patches / Campioni di collaudo

Test patches are compulsory and are supplied with the purpose of testing the net before its reutilization after a year of service.

In Reti Brembo we supply three test patches, each one with its traceability code perfectly printed and visible, and test them in our facilities.

I campioni di collaudo sono obbligatori e vengono forniti per eseguire un test prima del riutilizzo della rete dopo un anno di servizio. In Reti Brembo forniamo tre campioni di collaudo, ognuno con il suo codice di tracciabilità perfettamente stampato e visibile, ed eseguiamo i test nelle nostre strutture.



Digital
traceability
Tracciabilità
digitale

Test patches / Campioni di collaudo



Reti brembo s.r.l.
by
Visonets
Italia

Test report tool: DYNA 600 D/P



Data Produzione: 24/03/2023
Test #: 1521
Tipo Rete: Norma Uni 11808 EN 1263
Fibra: POLIPROPILENE
Dimensione maglia: 100
Misura: BLU
Note:

Data test: 24-03-2023 18:31:00
Cod. Rete: S231871
Rottura Kg: 200
Venditore / Produttore:
N.ro Ordine:
Cliente: RETIBREMBO
Esito: POSITIVO

Test #	Load Peak (N)	Load Peak (Kgf)	Elongation Peak (mm)	Strain Peak (%)	Brand Peak (%)
1	2.454,90	250,50	73,52	73,52	25,25
Min	2.454,90	250,50	73,52	73,52	25,25
Mean	2.454,90	250,50	73,52	73,52	25,25
Max	2.454,90	250,50	73,52	73,52	25,25

Joule Values
Kgf*mm : 5.224,64 J : 51,25 kJ : 0,05

FAC-SIMILE

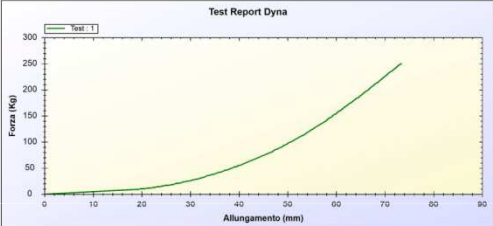



Reti brembo s.r.l.
by
Visonets
Italia

TEST RETE DI SICUREZZA NORMATIVA EN 1263.1

Reti brembo S.r.l. – Viale Vittorio Emanuele II, 43
24121 Bergamo (Bg)

Con la Presente, certifichiamo che:

E' stato eseguito il test di collaudo per la rete di sicurezza riportante il seguente codice di Tracciabilità:

270621

Il test corrispondente al relativo laccetto di rete campione, è stato eseguito in conformità alla normativa UNE EN1263.1

Il risultato del test del laccetto campione è:

POSITIVO (Valido per un anno)

Nota: E' di vitale importanza che la rete venga controllata ogni volta che verrà utilizzata e, in caso di rilevamento di qualsiasi danno o difetto, non deve essere utilizzata in nessun caso fino a quando non verrà controllata da una persona autorizzata o non verrà effettuata la riparazione corrispondente.

Bergamo (Bg), il 28 Marzo 2023.

RETIBREMBO S.R.L.
Via Vittorio Emanuele II n. 43
24121 BERGAMO (BG) - Tel. 035/6315134
Partita IVA 03775260163



FAC-SIMILE

SEDE LEGALE: Viale Vittorio Emanuele II, 43 – 24121 Bergamo (Bg) UNITA' LOCALE: Via Brughiera 21 – 24030 Palazzago (Bg)
TEL. 035/6315134 FAX: 035/362106 MICRO: 0471/94722 WWW.RETIBREMBO.COM INFO@RETIBREMBO.COM
C.F. / P. IVA : 03775260163 - Capitale sociale € 15.000,00 interamente versato - Iscritta al Reg. Imp. di Bergamo n° 03775260163

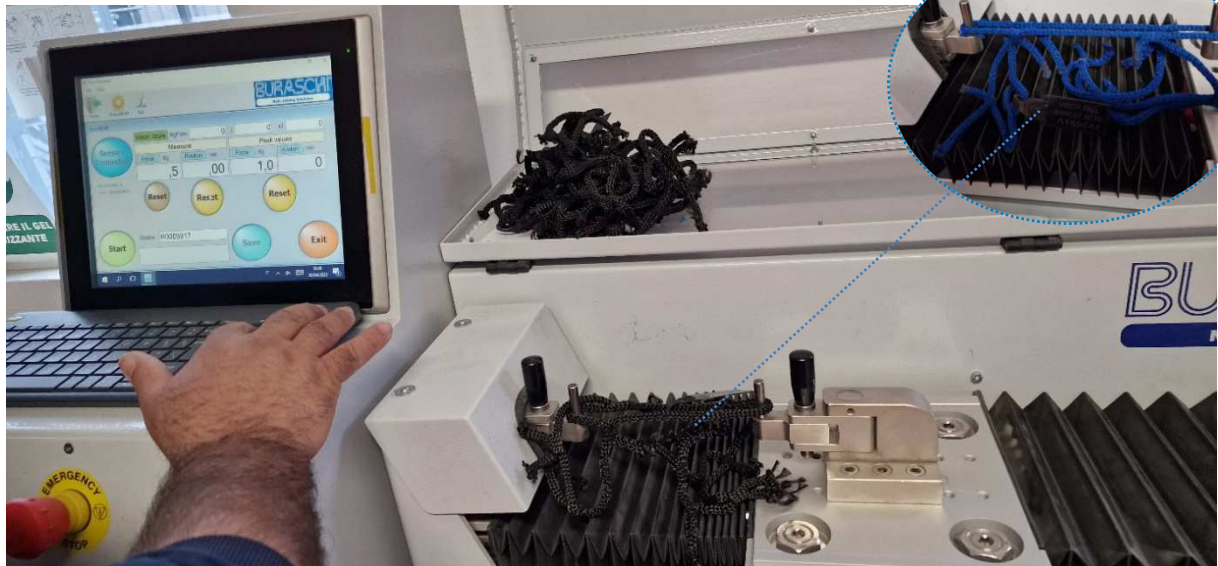

TECHNICAL SPECIFICATIONS CARATTERISTICHE TECNICHE





Nets
Reti
Ropes
Corde
Meshes
Maglie
Anchorages
Ancoraggi



Reti brembo s.r.l.

by
Visonets
Italia

NETS/RETI

Elements

Mesh - Series of ropes arranged in a basic geometric pattern (either in squares or diamonds) with four knots or connecting points, forming a net.

Net - Connection of meshes.

Safety Net - Net supported by a border rope, other supporting elements or a combination of these designed to catch persons falling from a height.

Mesh size (I_M) - Distance between two knots or connections of a mesh rope measured from the centre to the centre of these connections.

Class - Classification of the net with regard to energy absorption capacity and mesh size.

Nets classification - This standard specifies 4 classes of net with maximum mesh sizes (I_M) and nominated values of energy which may act on the net (E_A and E_B) as follows:

Classe A1:	$E_A = 2,3$ KJ	$I_M = 60$ mm
Classe A2:	$E_A = 2,3$ KJ	$I_M = 100$ mm
Classe B1:	$E_A = 4,4$ KJ	$I_M = 60$ mm
Classe B2:	$E_A = 4,4$ KJ	$I_M = 100$ mm

Elementi

Maglia - Serie di corde organizzate su un modello geometrico di base (in quadrati o rombi) che formano una rete.

Rete - Connessione di maglie.

Rete di sicurezza anticaduta - Rete supportata da una corda perimetrale o altri elementi di fissaggio, o una combinazione di essi, progettata per sostenere persone che cadono da una certa altezza.

Dimensioni della maglia (I_M) - Distanza fra due nodi o connessioni di corda di maglia, misurata da centro a centro di tali connessioni.

Classe - Classificazione delle reti rispetto alla loro capacità di assorbimento di energia e alle dimensioni della maglia.

Classificazione delle reti - In questa norma si specificano quattro classi di rete con le seguenti dimensioni massime di maglia (I_M) e le seguenti energie (E_A e E_B):

Classe A1:	$E_A = 2,3$ KJ	$I_M = 60$ mm
Classe A2:	$E_A = 2,3$ KJ	$I_M = 100$ mm
Classe B1:	$E_A = 4,4$ KJ	$I_M = 60$ mm
Classe B2:	$E_A = 4,4$ KJ	$I_M = 100$ mm

Polypropylene / Polipropilene

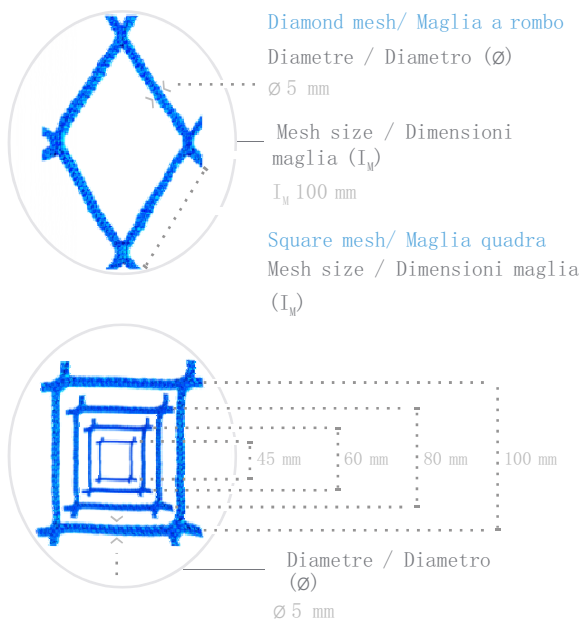

Polyamide / Poliammide

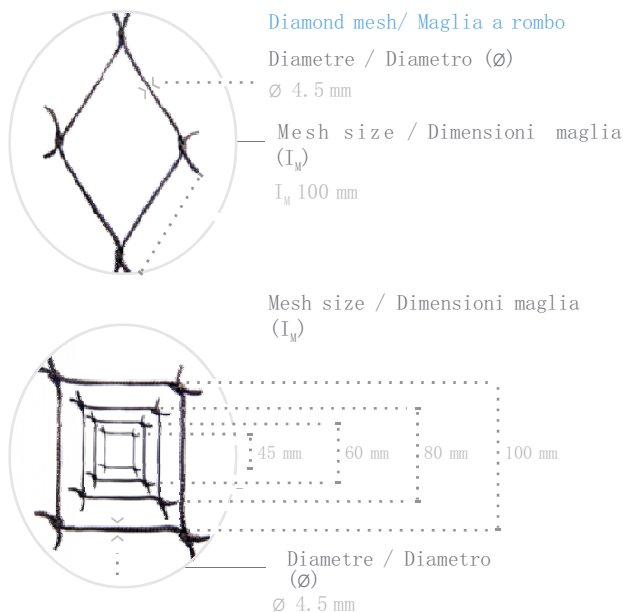



Net finishing

Safety nets can be composed by one, two or three layers.

The different types are composed with the combination of three types of meshes: main net, tools and debris.

Finiture della rete

Le reti di sicurezza anticaduta possono essere composte da uno, due o tre strati.

Le diverse varianti sono formate dalla combinazione di tre tipi di maglie: la rete principale, una per gli anticalcinacci e quella per i detriti.

Layers / Strati

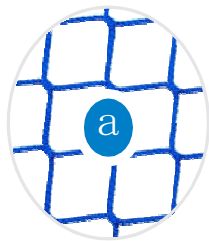

Net / Rete

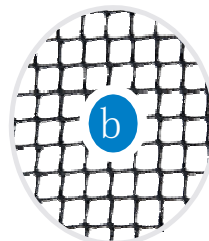

Tools / Anticalcinacci

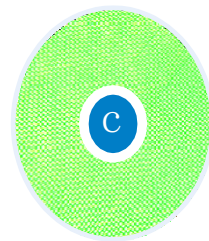

Debris / Detriti

Types / Tipi

One layer / Uno strato

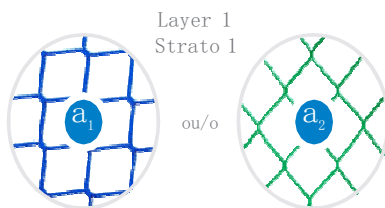

Two layers / Due strati

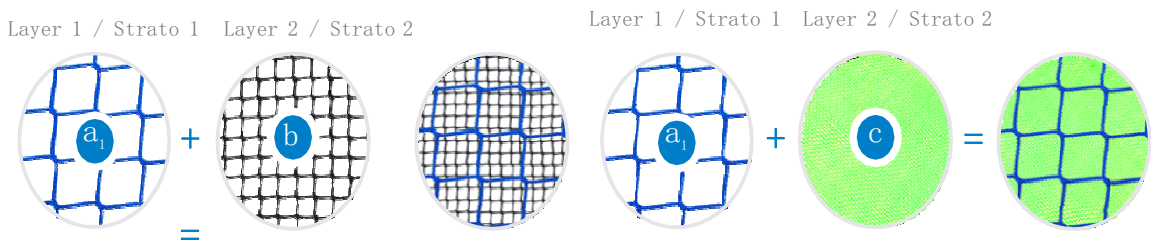

Three layers / Tre strati



HIGH TENACITY POLYPROPYLENE POLIPROPILENE AD ALTA TENACITA'

Diamond / Rombo

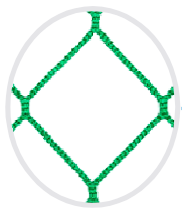

Knotless / Senza nodi

Square / Quadra

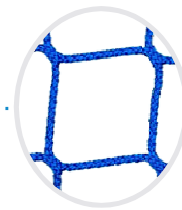

Knotted / Con nodi

- S** Safety net with border rope
- T** Safety net attached on brackets for horizontal use
- U** Safety net attached to supporting framework for vertical use
- V** Safety net with border rope attached to a gallow type support
- FN** Formwork net
- WN** Walk-on net / platform net / work positioning net
- VN** Vertical net
- TO** Tools
- DE** Debris net
- CO** Cover mesh

Colours available in blue / green.
Other colours please consult availability before ordering.

- S** Rete di sicurezza anticaduta con corda perimetrale
- T** Rete di sicurezza anticaduta fissata alle console per uso orizzontale
- U** Rete di sicurezza anticaduta attaccata ad una struttura di sostegno per uso verticale
- V** Rete di sicurezza anticaduta con corda perimetrale fissata ad un sostegno di tipo forca
- FN** Rete per puntelli
- WN** Rete per piattaforma di lavoro
- VN** Rete di recinzione verticale
- TO** Rete anticalcinacci
- DE** Maglia antidetriti
- CO** Maglia oscurante

Colori disponibili verde / azzurro. Per altri colori si prega di consultare la disponibilità prima di piazzare l'ordine.

Net finishing / Finiture della rete

Polypropylene / Polipropilene

One layer / Uno strato

One layer / Uno strato

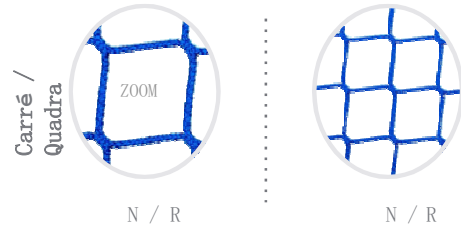
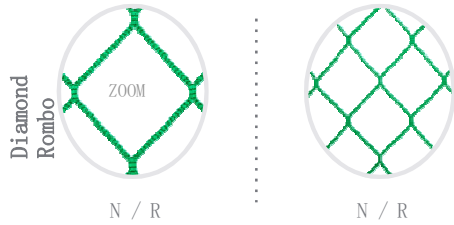

Net / Rete (N / R): 100x100 mm / ø 5 mm

Net / Rete (N / R): 100x100 mm / 60x60 mm / 45x45 mm / ø 5 mm

Two layers / Due strati

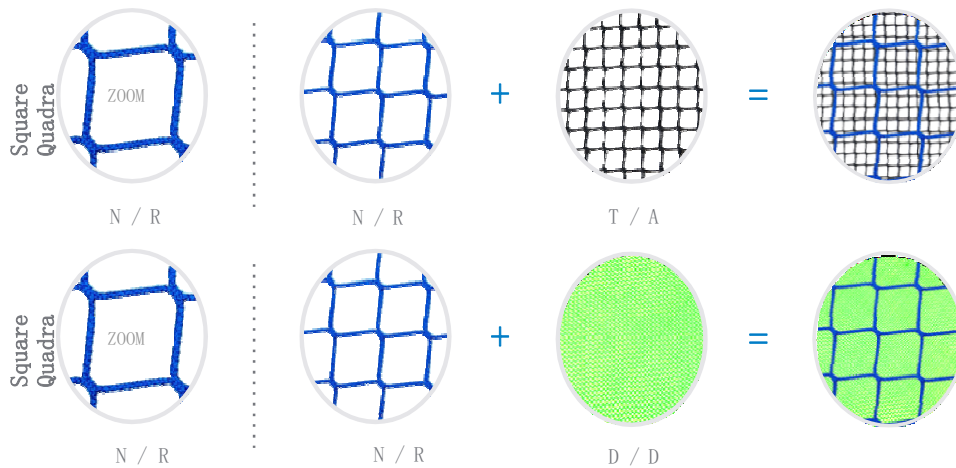

Net / Rete (N / R): 100x100 mm / 60x60 mm / 45x45 mm / ø 5 mm

Tools / Anticalcinacci (T / A): 20x20 mm / ø 2.3 mm
Debris / Detriti (D / D)

Three layers / Tre strati

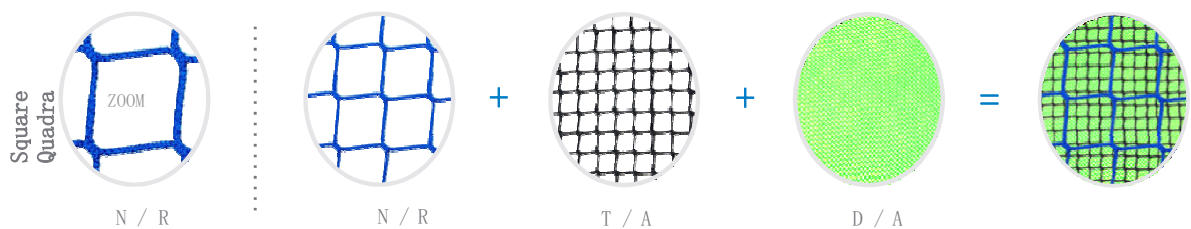

Filet / Rete (N / R): 100x100 mm / 60x60 mm / 45x45 mm / ø 5 mm

Tools / Anticalcinacci (T / A): 20x20 mm / ø 2.3 mm
Debris / Detriti (D / D)



Reti brembo s.r.l.

by
Visonets
Italia

HIGH TENACITY POLYAMIDE POLIAMMIDE AD ALTA TENACITA'



Square / Quadra



Knotted / Con nodo

- S** Safety net with border rope
- T** Safety net attached on brackets for horizontal use
- U** Safety net attached to supporting framework for vertical use
- V** Safety net with border rope attached to a gallow type support
- FN** Formwork net
- WN** Walk-on net / platform net / work positioning net
- VN** Vertical net
- TO** Tools
- DE** Debris net
- CO** Cover mesh

Colours available in blue / green.
Other colours please consult availability before ordering.

- S** Rete di sicurezza anticaduta con corda perimetrale
- T** Rete di sicurezza anticaduta fissata alle console per uso orizzontale
- U** Rete di sicurezza anticaduta attaccata ad una struttura di sostegno per uso verticale
- V** Rete di sicurezza anticaduta con corda perimetrale fissata ad un sostegno di tipo forca
- FN** Rete per puntelli
- WN** Rete per piattaforma di lavoro
- VN** Rete di recinzione verticale
- TO** Rete anticalcinacci
- DE** Maglia antidetrimenti
- CO** Maglia oscurante

Colori disponibili verde / azzurro. Per altri colori si prega di consultare la disponibilità prima di piazzare l'ordine.

Net finishing / Finiture della rete

Polyamide / Poliammide

One layer / Uno strato

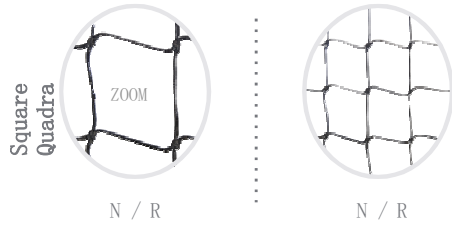

Net / Rete (N / R): 100x100 mm / ø 4.5 mm

Two layers / Due strati

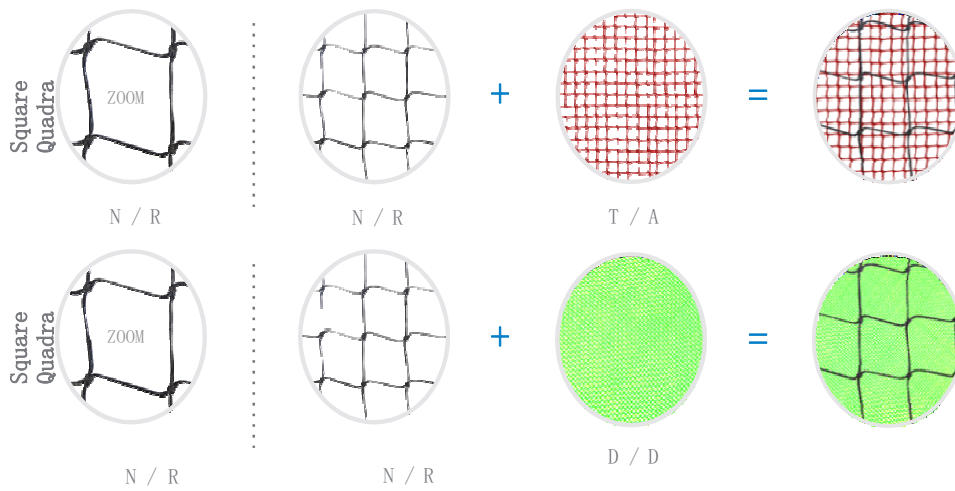

Net / Rete (N / R): 100x100 mm / ø 4.5 mm

Tools / Anticalcinacci (T / A): 20x20 mm / ø 2.3 mm
Debris / Detriti (D / D)

Three layers / Tre strati

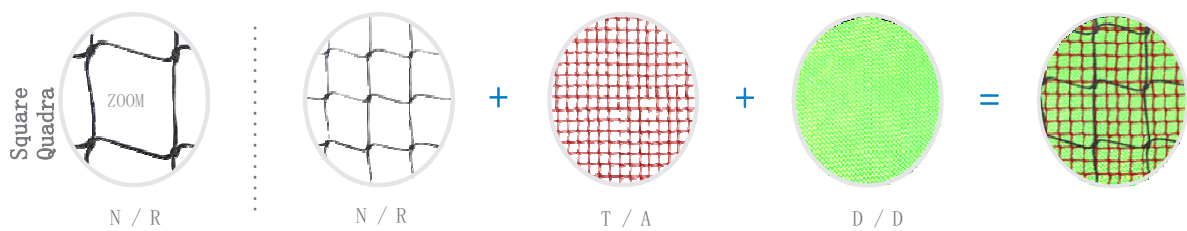

Net / Rete (N / R): 100x100 mm / ø 4.5 mm

Tools / Anticalcinacci (T / A): 20x20 mm / ø 2.3 mm
Debris / Detriti (D / D)









Reti brembo s.r.l.

by
Visonets
Italia

NETS RETI

Type Tipo	Minimum breaking energy Energia minima di rottura	Maximum mesh width Larghezza massima della maglia
A1	$E_A = 2,3 \text{ kJ}$	$I_M = 60 \text{ mm}$
A2	$E_A = 2,3 \text{ kJ}$	$I_M = 100 \text{ mm}$
B1	$E_B = 4,4 \text{ kJ}$	$I_M = 60 \text{ mm}$
B2	$E_B = 4,4 \text{ kJ}$	$I_M = 100 \text{ mm}$

Material Materiale (*)	Mesh width Larghezza della maglia (mm)	Diameter Diametro (mm)	Type Tipo		Knotted / Knotless Con nodo / Senza nodo (***)	Breaking force of the mesh rope Forza di rottura della corda di maglia (N)	Colour Colore	System Sistema (**)	Other uses Altri usi (****)
			Q	D					
•	100	5	•		KS	3200		S / U / V / FN / VN	1
•	100	5		•	KD	3200		V	1
•	100	3	•		KS	1250		FT	1
•	60	5	•		KS	3200		S / T / WN	1
•	45	5	•		KS	3200		S / WN	2
•	20	2.3	•		KS	800		T0	2
•	100	4.5	•		KD	3500		S	1

(*) PP: High Tenacity Polypropylene / Polipropilene alta tenacità

PA: Polyamide Haute Ténacité / Poliammide alta tenacità

(**) S: Safety net with border rope / Rete di sicurezza anticaduta con corda perimetrale

T: Safety net attached on brackets for horizontal use / Rete di sicurezza anticaduta fissata per utilizzo orizzontale

U: Safety net attached to supporting framework for vertical use / Rete di sicurezza anticaduta fissata a una struttura di sostegno per utilizzo verticale

V: Safety nets with border rope attached to a gallow type support / Rete di sicurezza anticaduta con corda perimetrale fissata a un sostegno di tipo forca

FN: Formwork net / Rete da solaio

FT: Filet sous-toiture / Rete per sottotetto

WN: Walk-on net / Platform net / work positioning net / Rete per piattaforma di lavoro

VN: Vertical net / Rete di chiusura perimetrale

T0: Tools net / Rete anticalcinacci

DE: Debris mesh / Maglia antidebris

CO: Cover mesh / Maglia oscurante

(***) KD: Knotted / Con nodo

KS: Knotless / Senza nodo

(****) 1: Sports field protection · Birds guards · Trailer nets · etc / Protezione campi sportivi · Protezioni antiuccelli · Reti di traino · ecc

2: Golf courses protection · Birds guards · Trailer nets · etc / Protezione campi sportivi · Protezioni antiuccelli · Reti di traino · ecc

ROPES CORDE

Material Materiale (*)		Type Tipo	Denomination Denominazione EN 1263-1	Diametre Diametro (mm)	Config. (**)		Minimum tensile strength Resistenza minima alla trazione (kN)					System Sistema
PP	PA				T	C	30	20	15	10	7,5	
•		Tie rope Corda di attacco	F	12	•			•				V
•		Tie rope Corda di attacco	G	12	•			•				V
•		Tie rope Corda di attacco	H	10	•					•		V
•		Tie rope Corda di attacco	J	10	•					•		V
•		Coupling rope Corda di unione	O	6	•						•	Multiple Multiplo
•		Tie rope Corda di attacco	Z	11	•					•		S
	•	Tie rope Corda di attacco	L	13		•		•				S
	•	Tie rope Corda di attacco	M	13		•		•				S

(*) PP: High tenacity Polypropylene/ Polipropilene ad alta tenacità

PA: High tenacity Polyamide / Poliammide ad alta tenacità

PE: Polyethylene / Polietilene

(**) T: Braided / Intrecciata

C: Twisted / Cablata



Reti brembo s.r.l.

by
Visonets
Italia

MESHES MAGLIE

Material Materiale		Weight Peso (g/m2)	Config. (*)		Colour Colore
PP	PE		W	R	
	.	130	.	.	● ● ● ● ★
	.	85	.		● ● ● ● ★
	.	50		.	★
.	.	110		.	● ● ● ● ★
.	.	90		.	● ● ● ● ★

(*) W: Non woven / Liscia

R: Raschel / Intrecciata

★ Possibility of any colour and various colours on same mesh.

Possibilità di qualsiasi colore e vari colori sulla stessa maglia.

ANCHORAGES ANCORAGGI

Anchorage type Tipo di ancoraggio	Material Materiale	Diametre Diametro (mm)	Extraction breaking load Carico di rottura all'estrazione (kN)	Finish Finitura
"Pig tail" anchorage Ancoraggio a ricciolo	Acier Acciaio	8	8	Zinc plated Galvanizzato
Expansive "Pig tail" anchorage Ancoraggio a ricciolo espansivo	Acier Acciaio	10	•	Zinc plated Galvanizzato
Expansive closed anchorage Ancoraggio espansivo chiuso	Acier Acciaio	10	•	Zinc plated Galvanizzato
Expansive closed anchorage Ancoraggio espansivo chiuso	Acier Acciaio	12	•	Zinc plated Galvanizzato
Expansive open anchorage Ancoraggio espansivo aperto	Acier Acciaio	10	•	Zinc plated Galvanizzato



Reti brembo s.r.l.

by
Visonets
Italia

STANDARD PRODUCT

PRODOTTO STANDARD

Material Materiale (*)	Mesh width Larghezza della maglia (mm)	Diameter Diametro (mm)	Type Tipo Q D	Knotted / Knotless Con nodo / Senza nodo (***)	Breaking force of the mesh rope Forza di rottura della corda di maglia (N)	Colour Colore	System Sistema (**)	Weight Peso (gr/m2)	Standard size in stock Misure disponibili a magazzino (m)
• PA	100	5	•	KS	3200		S	210	5x15 / 7x15 / 8x15 / 10x15 / 9x16
• PA	100	5	•	KS	3200		U	210	1x10 / 2x10 / 1x30 / 2x30
• PA	100	5	•	KS	3200		V	210	5x10
• PA	100	5	•	KS	3200		FN	210	1x10 / 2x10 / 1x16 / 2x16
• PA	100	5	•	KS	3200		VN	210	3x15
• PA	100	5	•	KD	3200		V	210	5x10
• PA	100	3	•	KS	1250		FT	95	1x10 / 1x20
• PA	60	5	•	KS	3200		S	345	(****)
• PA	60	5	•	KS	3200		T	345	3x6
• PA	60	5	•	KS	3200		WN	345	(****)
• PA	45	5	•	KS	3200		S	395	(****)
• PA	45	5	•	KS	3200		WN	395	(****)
• PA	20	2.3	•	KS	800		TO	300	(****)
• PA	100	4.5	•	KD	3500		S	210	(****)

(*) PP: High Tenacity Polypropylene / Polipropilene alta tenacità

PA: Polyamide Haute Ténacité / Poliammide alta tenacità

(**) S: Safety net with border rope / Rete di sicurezza anticaduta con corda perimetrale

T: Safety net attached on brackets for horizontal use / Rete di sicurezza anticaduta fissata per utilizzo orizzontale

U: Safety net attached to supporting framework for vertical use / Rete di sicurezza anticaduta fissata a una struttura di sostegno per utilizzo verticale

V: Safety nets with border rope attached to a gallow type support / Rete di sicurezza anticaduta con corda perimetrale fissata a un sostegno di tipo forca

FN: Formwork net / Rete da solaio

FT: Filet sous-toiture / Rete per sottotetto

WN: Walk-on net / Platform net / work positioning net / Rete per piattaforma di lavoro

VN: Vertical net / Rete di chiusura perimetrale

TO: Tools net / Rete anticalcinacci

DE: Debris mesh / Maglia antidetriti

CO: Cover mesh / Maglia oscurante

KD: Knotted / Con nodo

KS: Knotless / Senza nodo

(****) According to the project needs / In funzione delle necessità del progetto



Reti brembo s.r.l.

by
Visonets
Italia

SAFETY NETS SYSTEMS

SISTEMI DI RETI DI

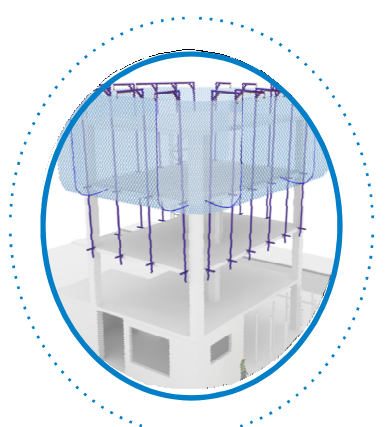
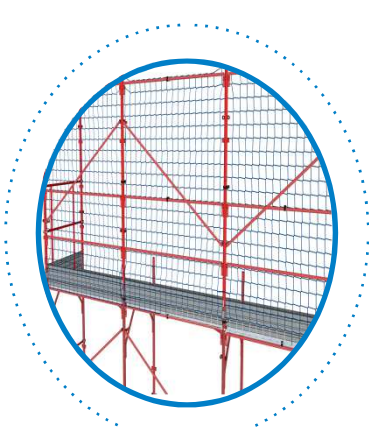
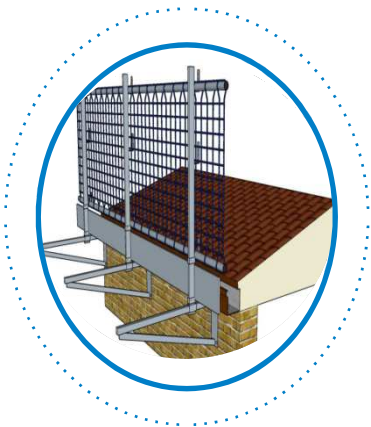
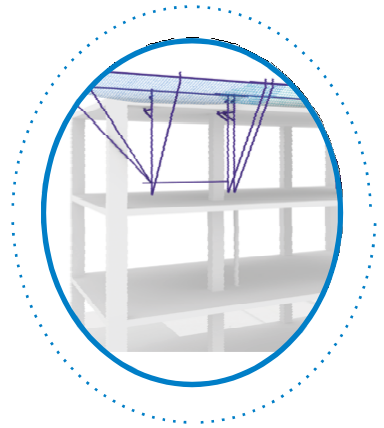
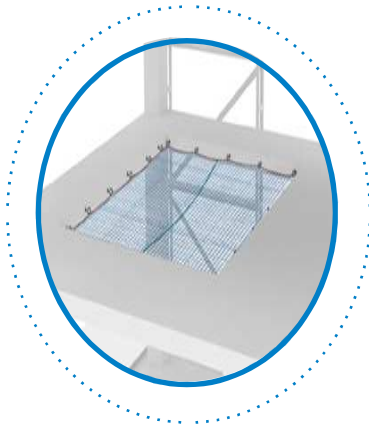
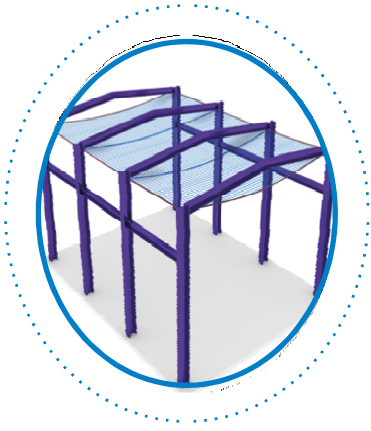



Reti brembo s.r.l.

by
Visonets
Italia

Systems
Sistemi

SICUREZZA ANTICADUTA

● Formwork nets
Rete per puntelli

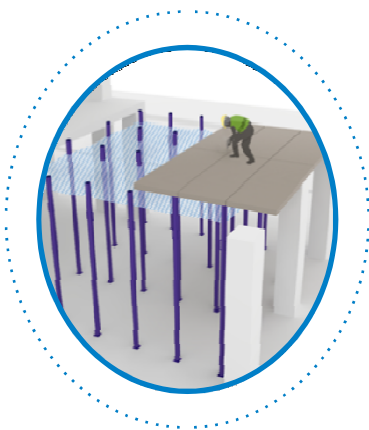

● Walk-on nets
Rete per piattaforma
di lavoro



● Vertical nets
Rete di chiusura
perimetrale

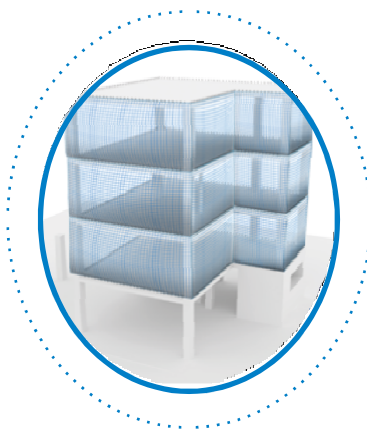

● BesSystem
BesSystem

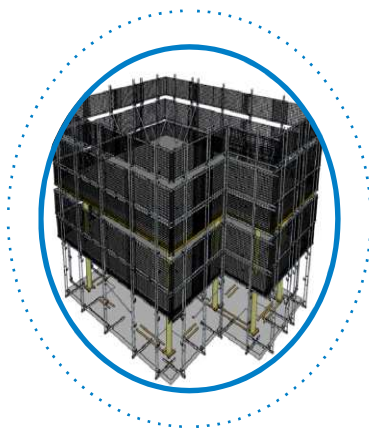

● "Adjustable
arm" system
Sistema
"Braccio
Regolabile"

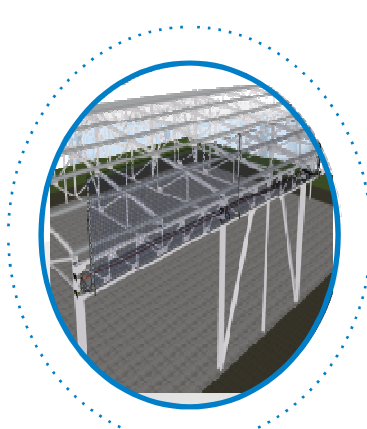

● Debris +
cover meshes
Maglia
antidetriti
e maglia
oscurante

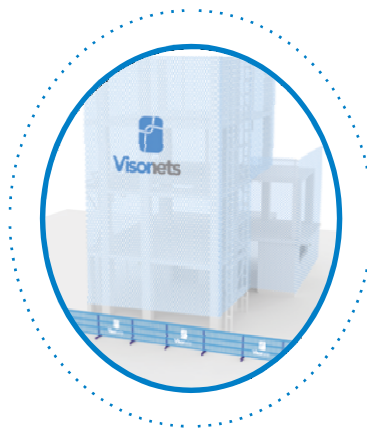

SAFETY NETS SYSTEMS

SISTEMI DI RETI DI

Inspection pit nets

- Rete per fosse d'ispezione



Truck loading system

- Sistema carico e scarico camion



Nets for working platform beneath road bridges

- Rete per piani di lavoro sotto i ponti stradali



Wire mesh

- Rete metallica per lucernari

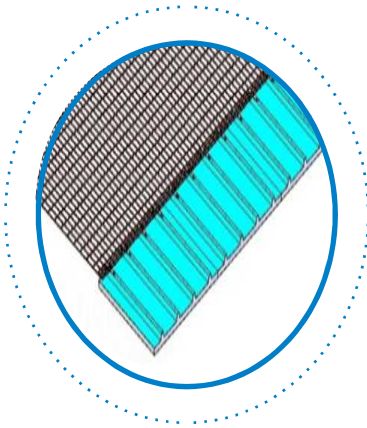

Type "M" skylight nets

- Rete definitiva per lucernari tipo "M"

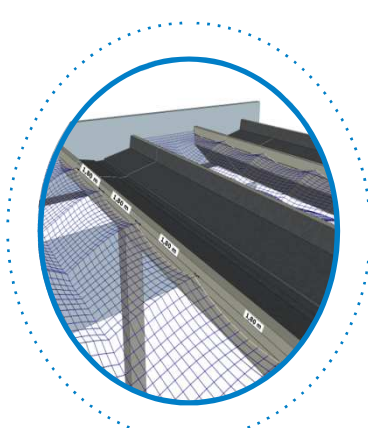

Skylight nets with ratchet belt

- Rete per lucernari con fascia a cricchetto

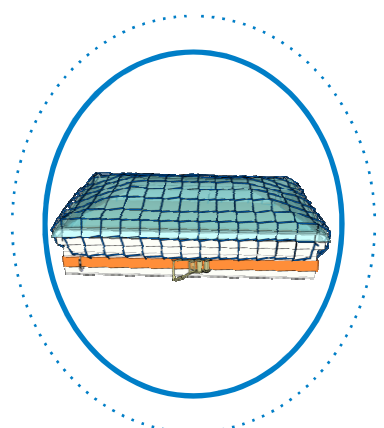



Reti brembo s.r.l.

by
Visonets
Italia

Systems
Sistemi

SICUREZZA ANTICADUTA

- **Anti-debris nets**
Reti
anticalcinacci

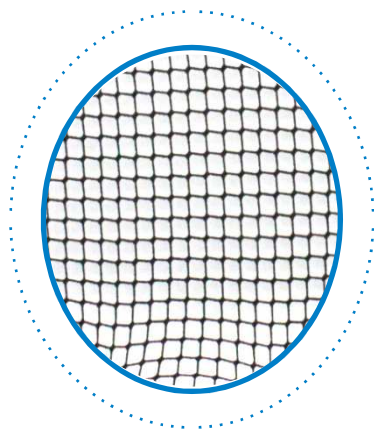

- **Anti-bird nets**
Rete
antivolatili



- **Soccer nets**
Rete per porte
da calcio

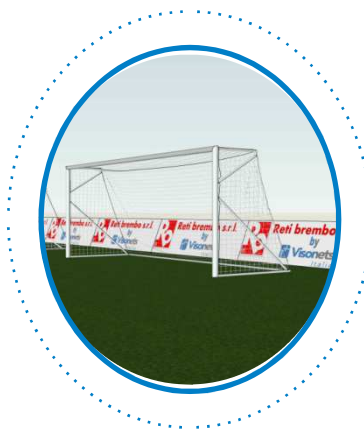

- **Fork nets**
Rete per forca

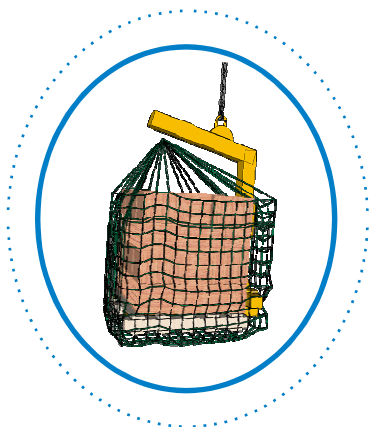

- **Shelving nets**
Rete per scaffali

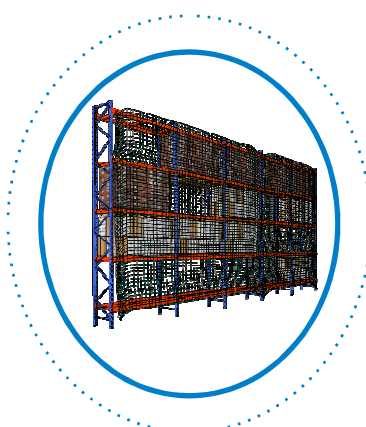



RETI BREMBO-S

Type S certified system
Sistema certificato Tipo S

Metal
structure

Struttura
metallica



Steel
deck

Copertura
in
acciaio

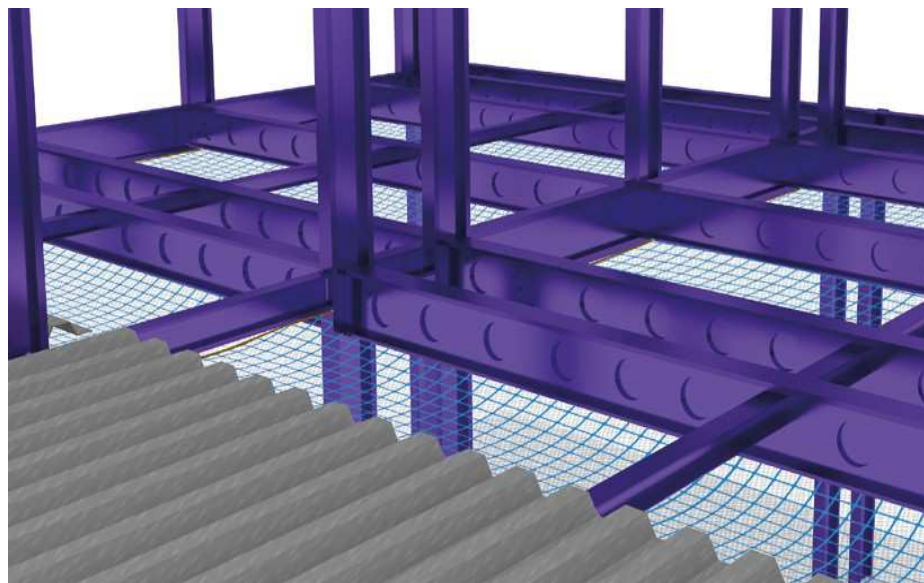

Concrete
structure

Struttura in
cemento

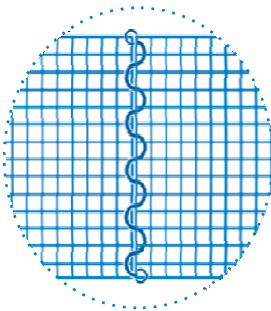
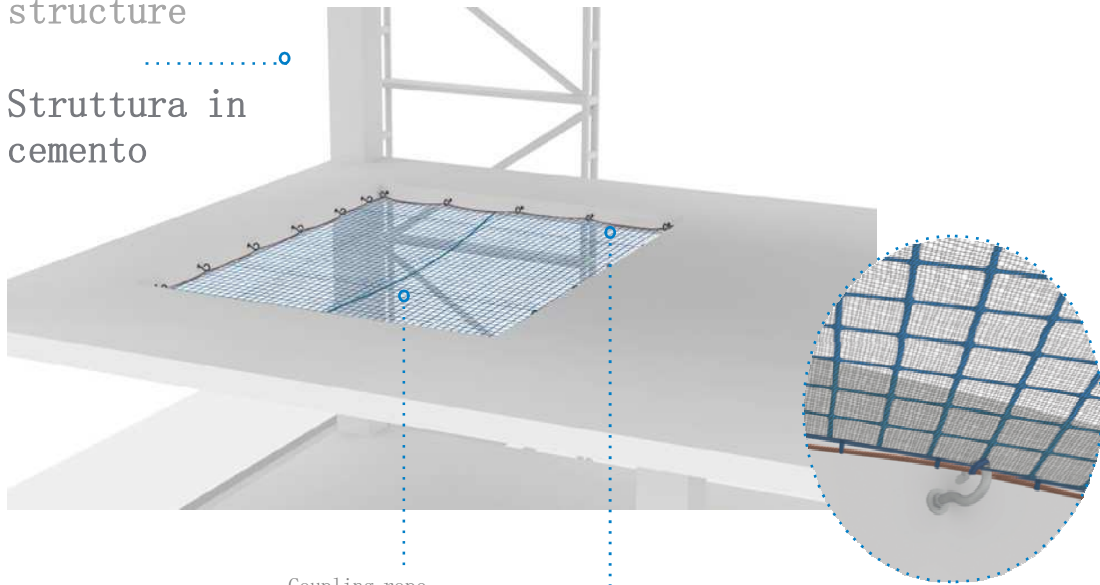

Coupling rope
Corda di
unione/cucitura

Tie rope
Corda di
attacco



Expansive "pig tail" anchorage
Ancoraggio a ricciolo espansivo

10 x 120 mm

M12 x 160 mm

Type Tipo	Minimum tensile strength Resistenza minima alla trazione (kN)	Ø (mm)
0	7,5	6

Type Tipo	Minimum tensile strength Resistenza minima alla trazione (kN)	Ø (mm)
M	30	12
Z (*)	15	8

(*) Two branches of load · Due rami di carico



Reti brembo s.r.l.

by
Visonets
Italia



Fotografie sui cantieri
Construction site pictures

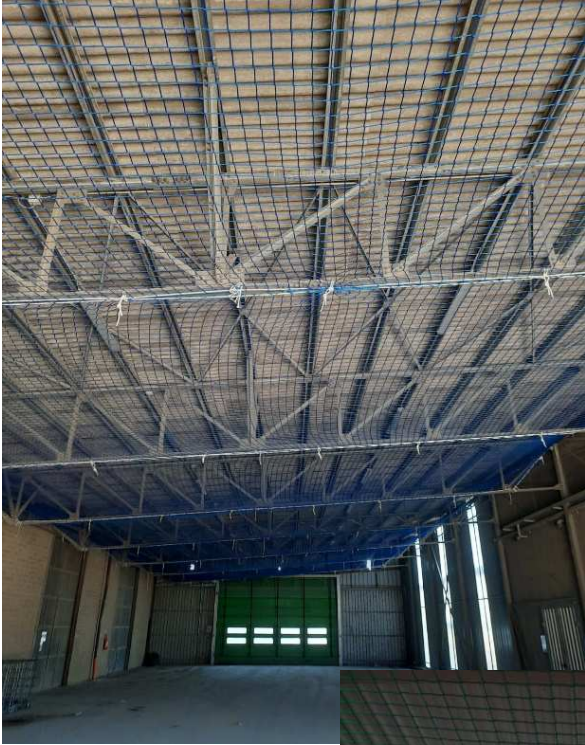



Accessori di fissaggio
Fixing accessories



Gancio + tassello
Pigtail anchor



Moschettone
Carabiner



Gancio da legno
Wood screw



Telo impermeabile
Waterproof mesh

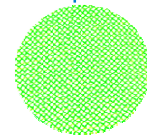

Telo antidetriti
Debris mesh



Corda di cucitura
Coupling rope



Corda di legatura
Tie rope



Ancoraggio chimico
Chemical anchor



Gancio in classe A
Class A anchor



Fascia a cricchetto
Ratchet belt



Occhiolo per cemento armato
Concrete eyebolt



Reti brembo s.r.l.

by
Visonets
Italia



RETI BREMBO-YS

Type YS certified system
Sistema certificato Tipo YS



100 mm mesh net with shorter side between 2 and 3 m, and longer side not less than 4 m
Rete a maglia 100 mm, con lato corto compreso tra 2 m e 3 m e lato lungo non minore di 4 m (UNI 11808-2)

Accessori di fissaggio Fixing accessories



Gancio + tassello
Pigtail anchor



Moschettone
Carabiner



Gancio da legno
Wood screw



Gancio in classe A
Class A anchor



Occhiolo per cem. armato
Concrete eyebolt



Corda di cucitura
Coupling rope



Corda di legatura
Tie rope



Ancoraggio chimico
Chemical anchor



Fascia a cricchetto
Ratchet belt

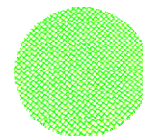

Telo antidetriti
Debris mesh



Telo impermeabile
Waterproof mesh

RETI BREMBO-XS
Type XS certified system
Sistema certificato Tipo XS



60 mm mesh net with shorter side between 3 and 5 m
Rete a maglia 60 mm, con lato corto compreso da 3 m e 5 m (UNI 11808-1)



Accessori di fissaggio Fixing accessories



Gancio + tassello
Pigtail anchor



Moschettone
Carabiner



Gancio da legno
Wood screw



Gancio in classe A
Class A anchor



Occhiolo per cem. armato
Concrete eyebolt



Corda di cucitura
Coupling rope



Corda di legatura
Tie rope



Ancoraggio chimico
Chemical anchor



Fascia a cricchetto
Ratchet belt

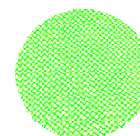

Telo antidetriti
Debris mesh



Telo impermeabile
Waterproof mesh



RETI BREMBO T-EVO FAN

Type T certified system
Sistema certificato Tipo T

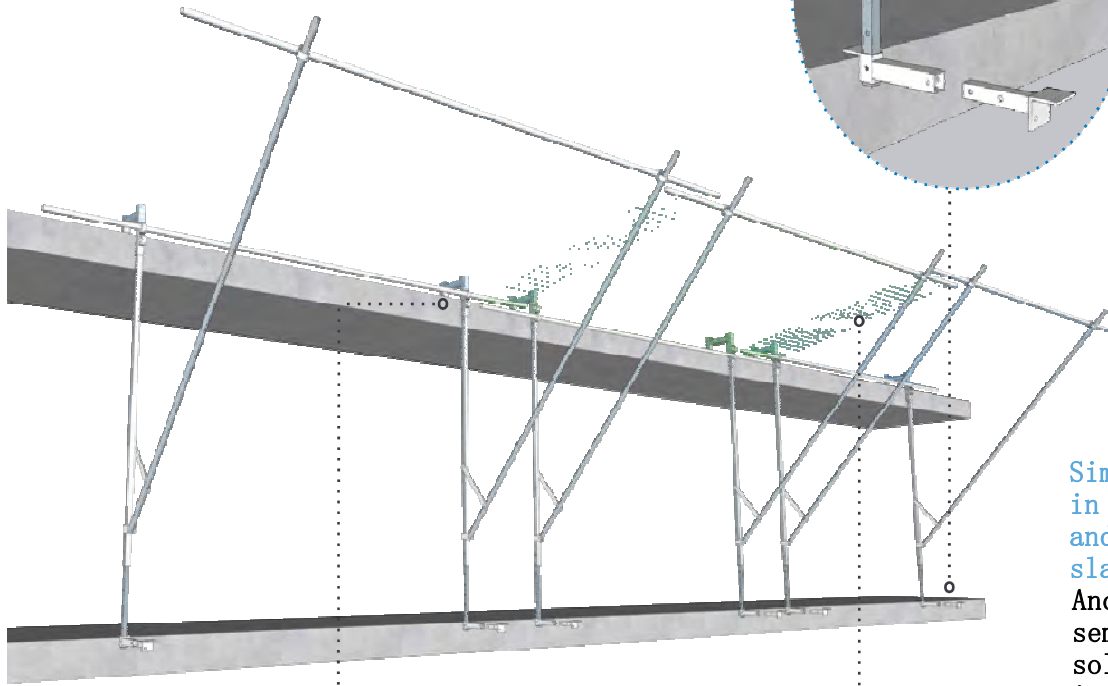
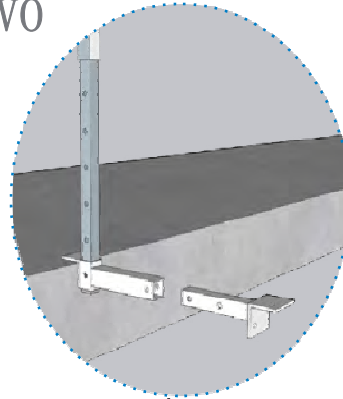

Simple anchor
in upper
and lower
slabs
Ancoraggio
semplice su
solaio
inferiore e
superiore

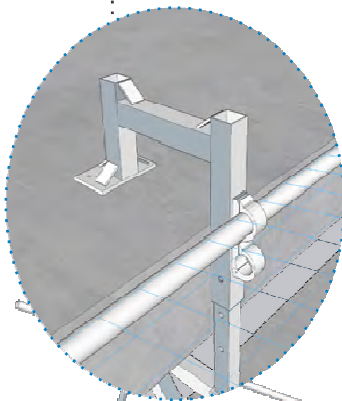

Minimum overlapping 75cm
Sormonto minimo 75 cm

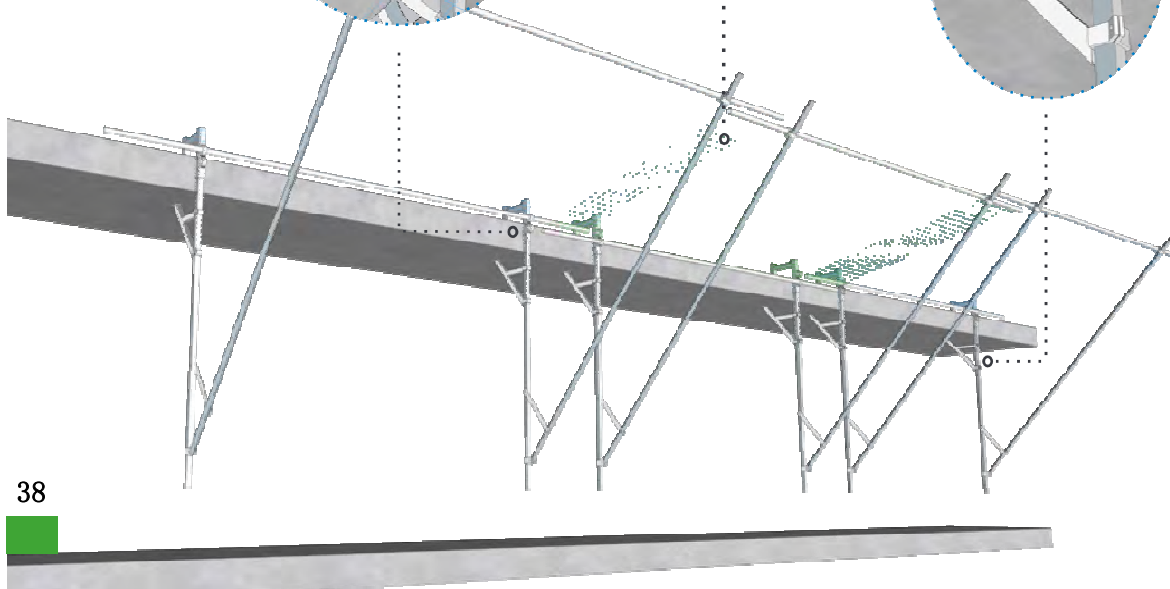
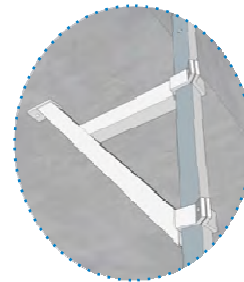

Double
anchor in
upper slab
Doppio
ancoraggio
sul solaio
superiore

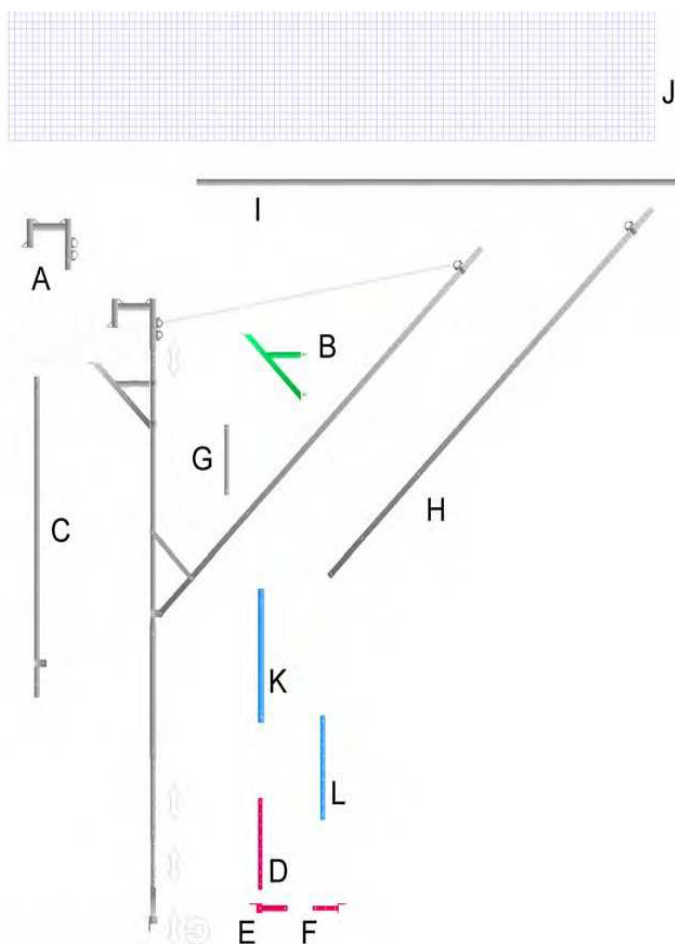

Installation
Scheme
Schema di
installazione

Technical Specifications / Specifiche tecniche

Item/ Articolo	Description / Descrizione	Material / Materiale	Weight / Peso (kg)
A	Slab attachment / Ancoraggio solaio	Galvanised steel / Acciaio zincato	9
B	Knee brace / Ancoraggio angolare	Galvanised steel / Acciaio zincato	7
C	Vertical tube / Tubo verticale	Galvanised steel / Acciaio zincato	12.5
D	Extension leg / Prolunga	Galvanised steel / Acciaio zincato	2.5
E	Extension attachment / Ancoraggio d'estensione	Galvanised steel / Acciaio zincato	2.5
F	Extender arm / Braccio estensore	Galvanised steel / Acciaio zincato	1.8
G	Wind lock / Sicura	Galvanised steel / Acciaio zincato	1.5
H	Diagonal tube / Tubo diagonale	Aluminium / Alluminio	8.5
I	Horizontal tube / Tubo orizzontale	Aluminium / Alluminio	11.3
J1	Safety net 1 layer / Rete di sicurezza 1 strato	Knotless polypropylene / Polipropilene senza nodi	Safety net 60 mm mesh = 6.85 kg Rete di sicurezza maglia 60 mm = 6.85 kg
J2.1	Safety net 2 layers / Rete di sicurezza 2 strati	Knotless polypropylene / Polipropilene senza nodi	Safety net 60 mm mesh + tools net 20 mm mesh = 11.25 kg Rete di sicurezza 60 mm + rete maglia 20 mm = 11.25 kg
J2.2	Safety net 2 layers / Rete di sicurezza 2 strati	Knotless polypropylene / polyethylene Polipropilene / polietilene senza nodi	Safety net 60 mm mesh + debris mesh = 8.55 kg Rete di sicurezza 60 mm + antidetriti = 8.55 kg
J3	Safety net 3 layers / Rete di sicurezza 3 strati	Knotless polypropylene / polyethylene Polipropilene / polietilene senza nodi	Safety net 60 mm mesh + tools net 20 mm mesh + debris mesh = 12.95 kg Rete di sicurezza 60 mm + rete maglia 20 mm + antidetriti = 12.95 kg
K (*)	Vertical tube extension / Estensione del tubo verticale	Galvanised steel / Acciaio zincato	5.9
L (*)	Vertical telescopic tube / Tubo telescopico verticale	Galvanised steel / Acciaio zincato	3.8

(*) Only necessary if the distance between slabs exceeds 3.50 m (up to a maximum of 5 m)
(*) Necessario solo se la distanza tra i solai eccede 3,50m (fino ad un massimo di 5 m)



RETI BREMBO T-EVO FAN

Type T certified system
Sistema certificato Tipo T

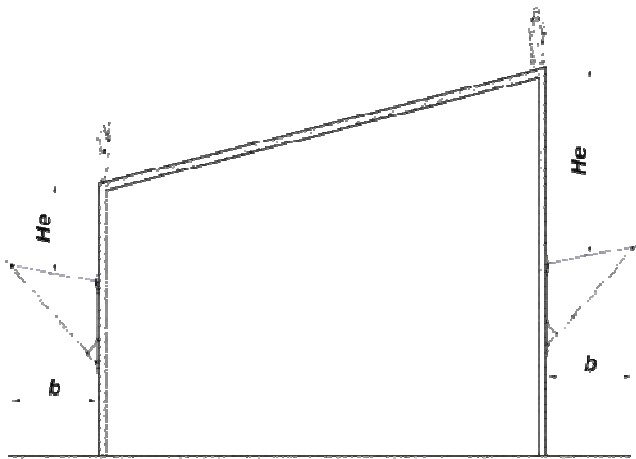

Fall height Altezza di caduta	$\leq 1,0$ m	$\leq 3,0$ m (max. recommended) $\leq 3,0$ m (max. consigliato)	$\leq 6,0$ m
Pick-up width b Larghezza di raccolta	$\geq 2,0$ m	$\geq 2,5$ m	$\geq 3,0$ m

Durante lo sviluppo di questo sistema, a parte i requisiti tecnici richiesti dallo standard EN 1263.1:2014, il nostro team ha anche preso in considerazione l'aspetto ergonomico per ridurre al massimo il peso del sistema rispetto al precedente, combinando acciaio e profili strutturali in alluminio.

Di conseguenza, abbiamo ottenuto un sistema versatile e facile da installare, che potrà fornirvi una semplice ed efficace soluzione.

During the development of this system, apart from all the technical aspects required by the current standard EN 1263.1:2014, our technical team has also taken into account ergonomic aspects reducing to the maximum the weight of the system in comparison with the previous one combining steel and structural aluminium profiles.

As a result, we obtain a versatile and of easy installation and handling manufacturing system which will provide you a simple and effective solution.

T-Evo product is a collective protection system that includes:

- » Textile elements (safety netting)
- » Metallic structures (steel and aluminium tubes)

This system contains all accessories needed for installation.

The T-Evo system is not limited to the anchoring elements that we initially propose to you. On the contrary, our technical department, aware of the peculiarities of the constructive projects, is able to develop other anchors for different kinds of works.



Il prodotto T-Evo è un sistema di protezione collettiva che include:

- » Elementi tessili (rete di sicurezza)
- » Struttura metallica (tubi di acciaio e alluminio)

Questo sistema contiene tutti gli accessori necessari per la sua installazione.

Il sistema T-Evo non è limitato agli elementi di ancoraggio che proponiamo inizialmente. Al contrario, il nostro ufficio tecnico, consapevole delle peculiarità dei progetti costruttivi, è in grado di sviluppare altri ancoraggi per diversi tipi di lavorazioni.

Fotografie sui cantieri Construction site pictures

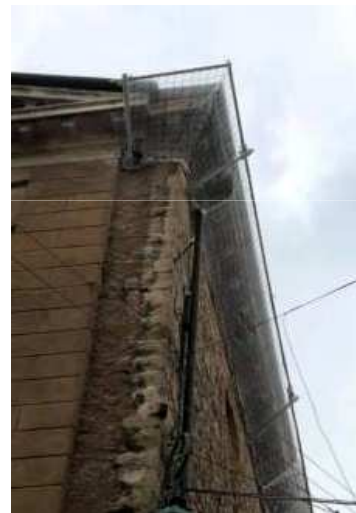

Accessori di fissaggio Fixing accessories



Gancio + tassello
Pigtail anchor



Corda di cucitura
Coupling rope



Corda di legatura
Tie rope



Ancoraggio chimico
Chemical anchor



Moschettone
Carabiner



Ancoraggio passante
Through screw



Vite da cemento
Concrete screw



RETI BREMBO -U: Sistema di reti e correnti

Type U certified system
Sistema certificato Tipo U

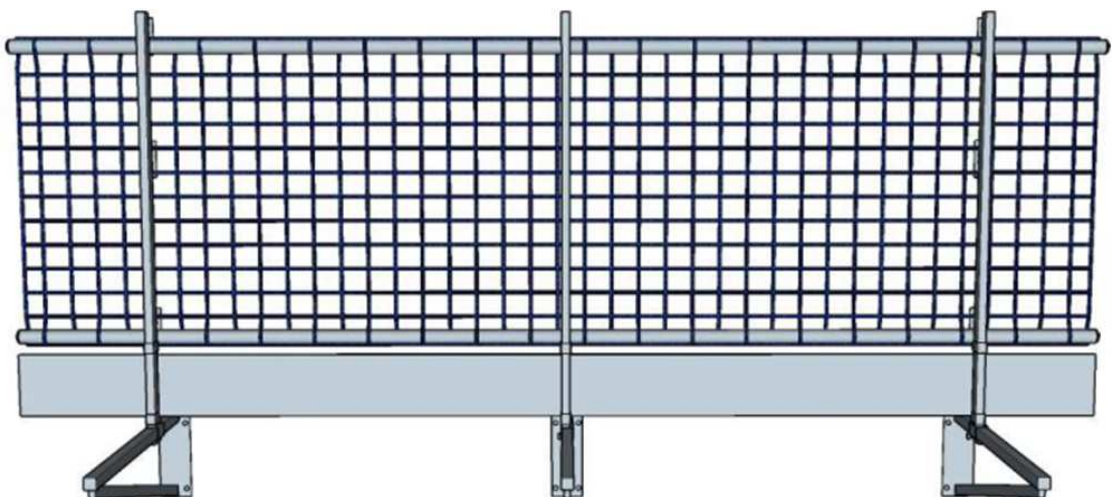
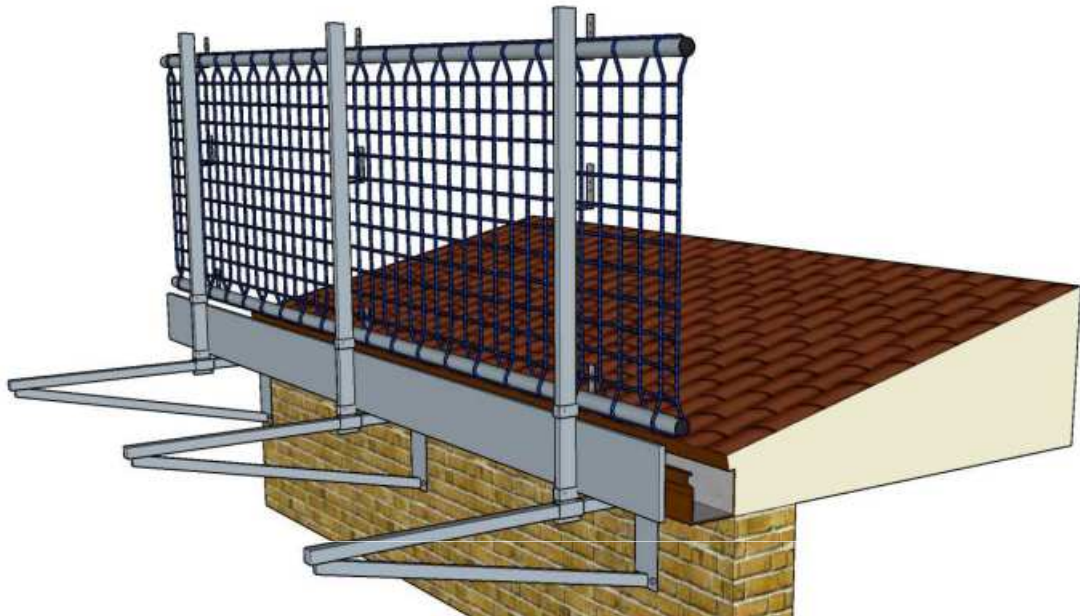

Fotografie sui cantieri Construction site pictures

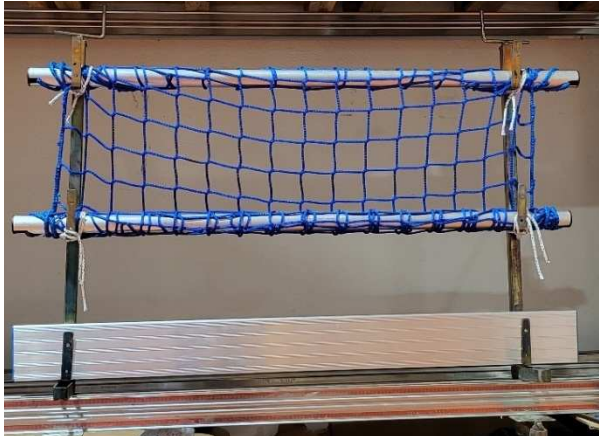

Accessori di fissaggio Fixing accessories



Gancio + tassello
Pigtail+drop in anchor



Moschettone
Carabiner



Gancio in classe A
Class A anchor



Fascetta con fibbia
Band with buckle



Corda di cucitura
Coupling rope



Corda di legatura
Tie rope



Ancoraggio chimico
Chemical anchor



Fascia a cricchetto
Ratchet belt



Reti brembo s.r.l.

by
Visonets
Italia



RETI BREMBO -U: Rete su struttura tubolare

Type U certified system
Sistema certificato Tipo U

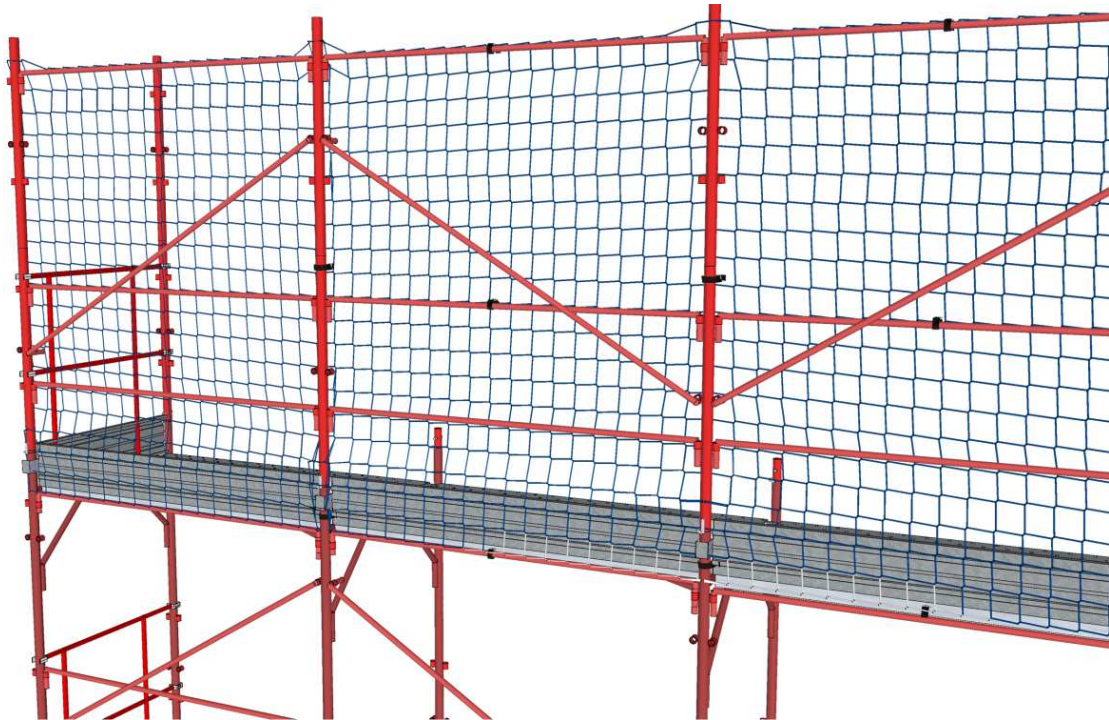
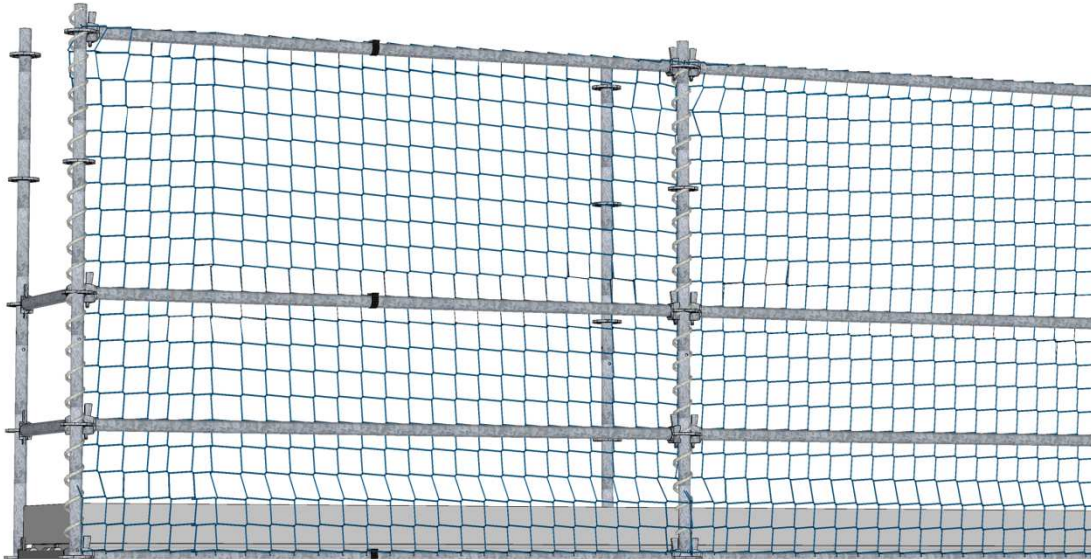

Fotografie sui cantieri Construction site pictures



Accessori di fissaggio Fixing accessories



Gancio + tassello
Pigtail anchor



Moschettone
Carabiner



Gancio in classe A
Class A anchor



Fascetta con fibbia
Band with buckle



Corda di cucitura
Coupling rope



Corda di legatura
Tie rope



Ancoraggio chimico
Chemical anchor



Fascia a cricchetto
Ratchet belt



Reti brembo s.r.l.

by
Visonets
Italia



RETI BREMBO -V

Type V certified system

Sistema certificato Tipo V

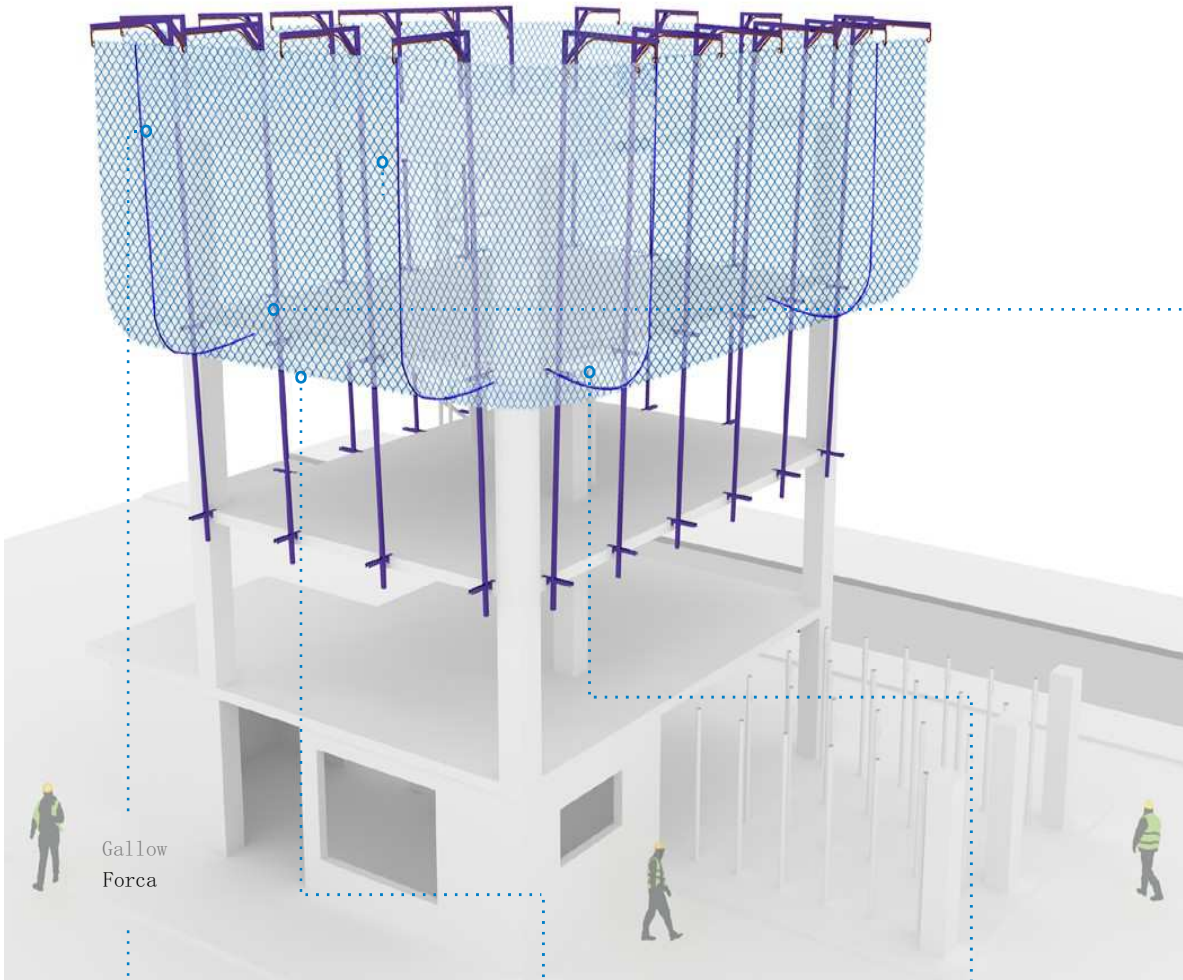

Gallow
Forca

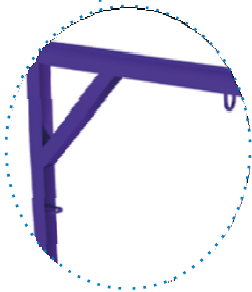

Gallow support
Sostegno di tipo forca

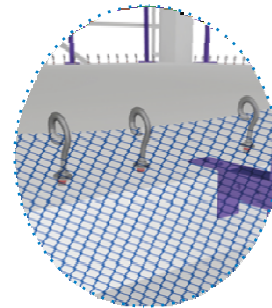
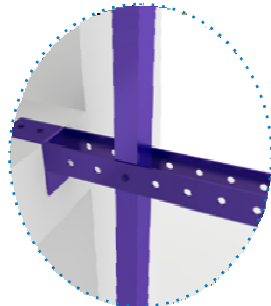

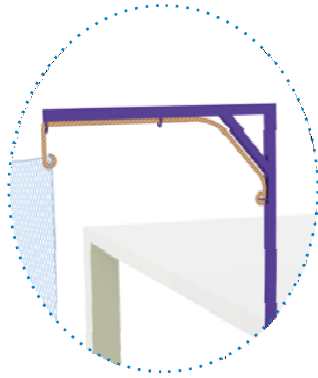

Type Tipo	Minimum tensile strength Resistenza minima alla trazione (kN)	Ø (mm)
G	20	10
J (*)	15	8

(*) Two branches of load
Due rami di carico

Coupling rope
Corda di
unione/cucitura

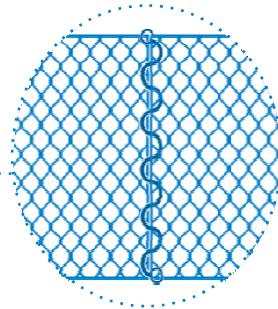

Type Tipo	Minimum tensile strength Resistenza minima alla trazione (kN)	Ø (mm)
0	7,5	6



Expansive "Pig tail" anchorage
Ancoraggio a ricciolo espansivo

- 1) Max. distance between anchorages
Distanza massima fra i ganci = 0.50 m
- 2) Max. distance gallow-anchorages distance
Distanza massima tra gancio e forza = 0.20 m



Fotografie sui cantieri Construction site pictures



Accessori di fissaggio Fixing accessories



Gancio + tassello
Pigtail anchor



Moschettone
Carabiner



Ancoraggio chimico
Chemical anchor



Fascia a cricchetto
Ratchet belt



Corda di cucitura
Coupling rope



Corda di legatura
Tie rope



Accessorio forca
Fork accessory



Cassettino
Box



Forca
Gallow



Reti brembo s.r.l.

by
Visonets
Italia

Formwork nets

Sistema di protezione delle reti per puntelli

UNE EN 81653:2003 - B

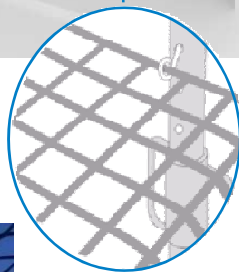
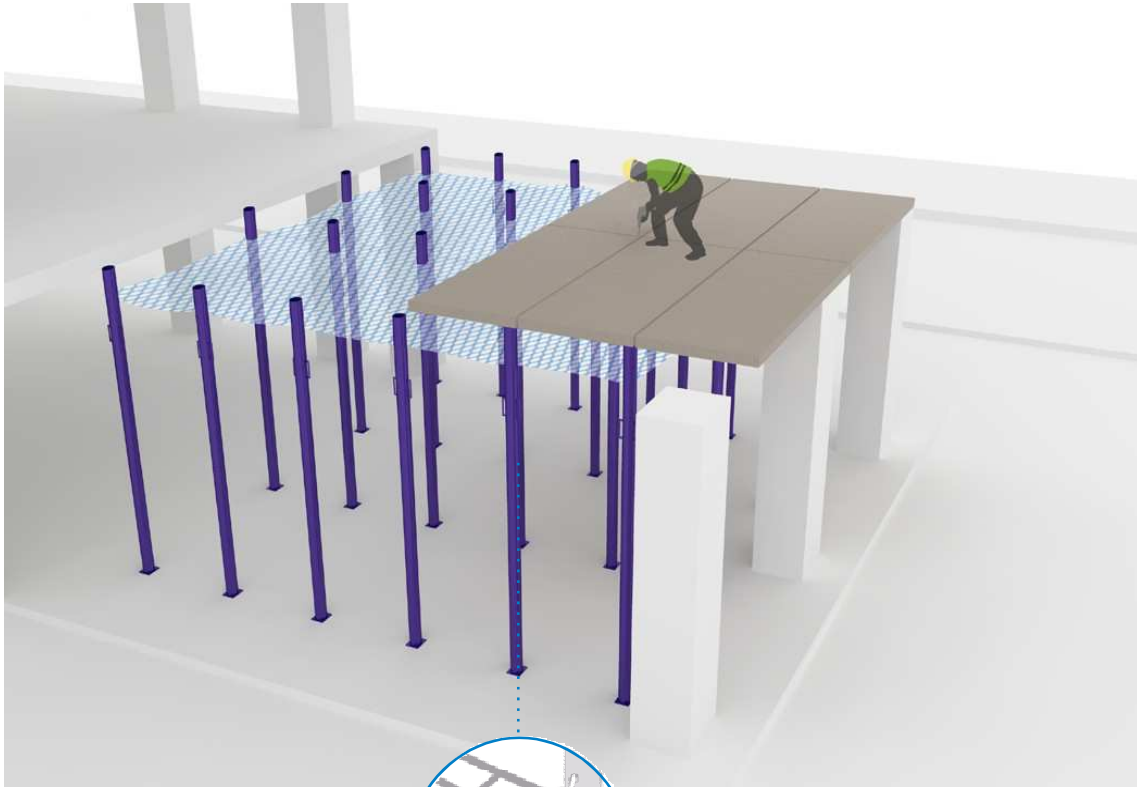

 "Pig tail" anchorage
Ancoraggio a ricciolo



Corda di legatura

Tie rope



Corda di cucitura

Coupling rope



Reti brembo s.r.l.

by
Visonets
Italia

Walk-on Nets

Rete per piattaforma di lavoro

Systems
Sistemi

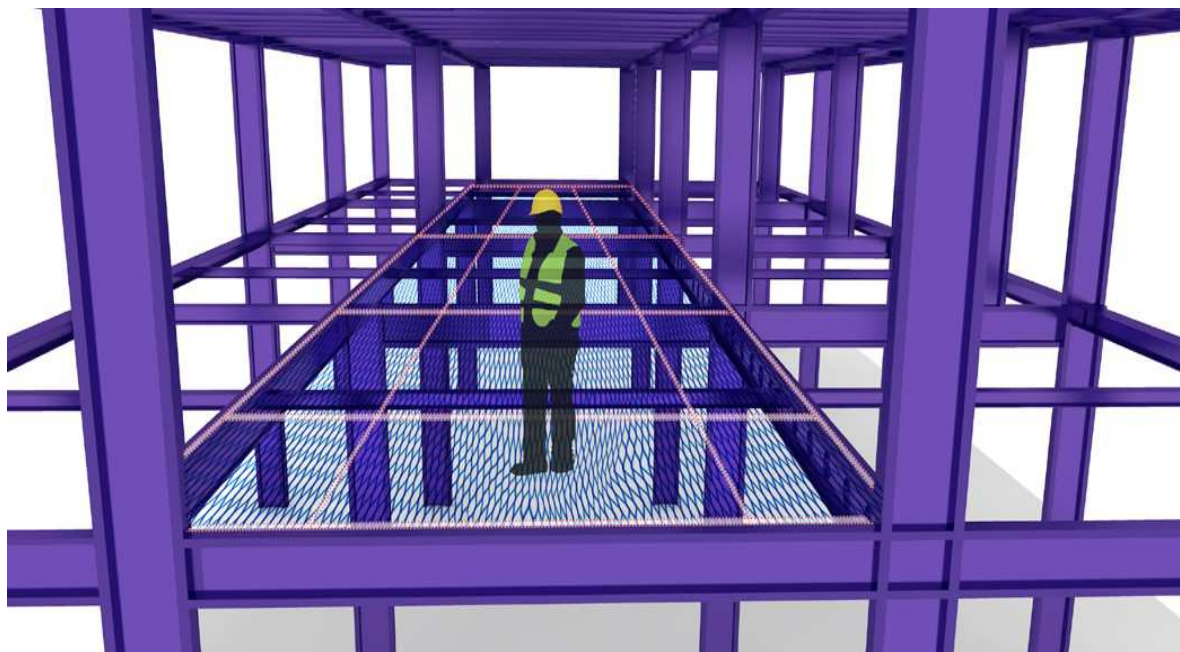

Accessori di fissaggio Fixing accessories



Gancio + tassello
Pigtail anchor



Moschettone
Carabiner



Corda di cucitura
Coupling rope



Corda di legatura
Tie rope



Ancoraggio chimico
Chemical anchor



Fascia a cricchetto
Ratchet belt



Vertical nets

Sistema di chiusura perimetrale

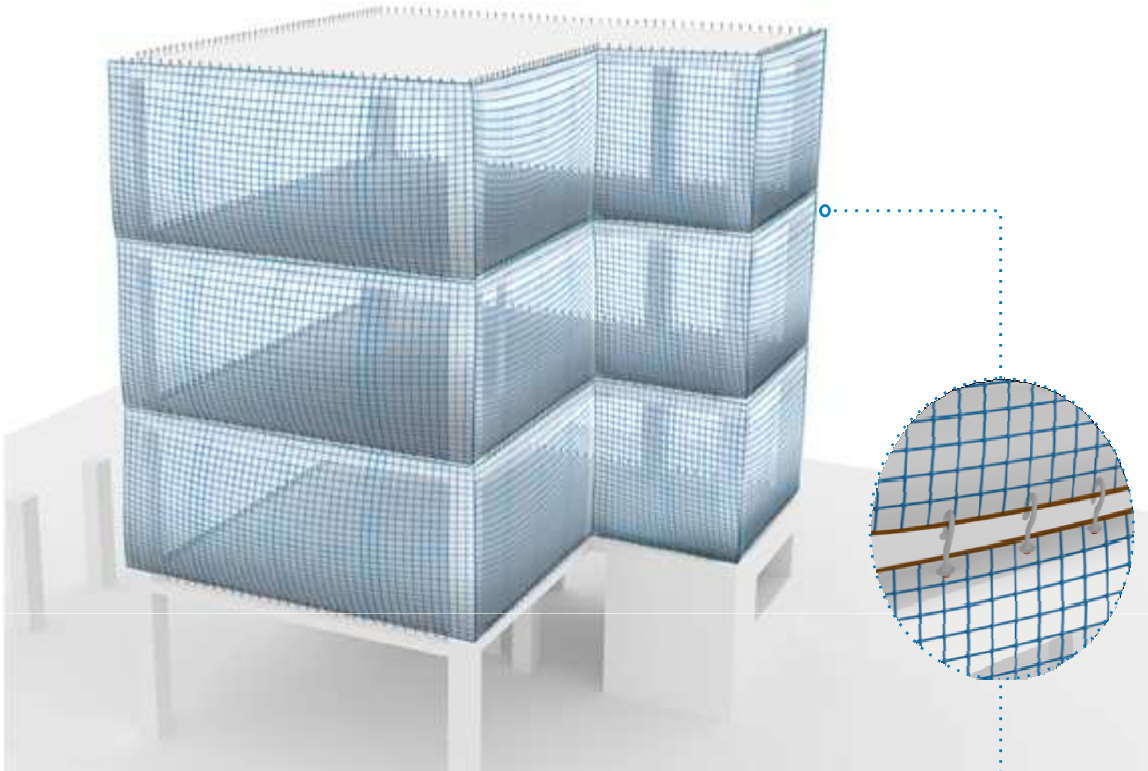

Fotografie sui cantieri Construction site pictures



Expansive "Pig tail" anchorage
Ancoraggio a ricciolo espansivo

Max. distance between anchorages
Distanza massima fra i ganci 0.50 m

A diagram showing a close-up of the 'pig tail' anchorage system. It features a metal hook that fits into a slot on a horizontal metal rail. The hook has a curved, tail-like shape. The diagram is enclosed in a dashed blue border.



Accessori di fissaggio Fixing accessories



Gancio + tassello
Pigtail anchor



Moschettone
Carabiner



Gancio in classe A
Class A anchor



Fascetta con fibbia
Band with buckle



Ancoraggio chimico
Chemical anchor



Corda di cucitura
Coupling rope



Corda di legatura
Tie rope



Fascia a cricchetto
Ratchet belt



Threaded rod
Barra filettata



Vite da cemento
Concrete screw



Expansive "Pig tail"
anchorage
Ancoraggio a ricciolo
espansivo



Reti brembo s.r.l.

by
Visonets
Italia

BesSystem

BesSystem

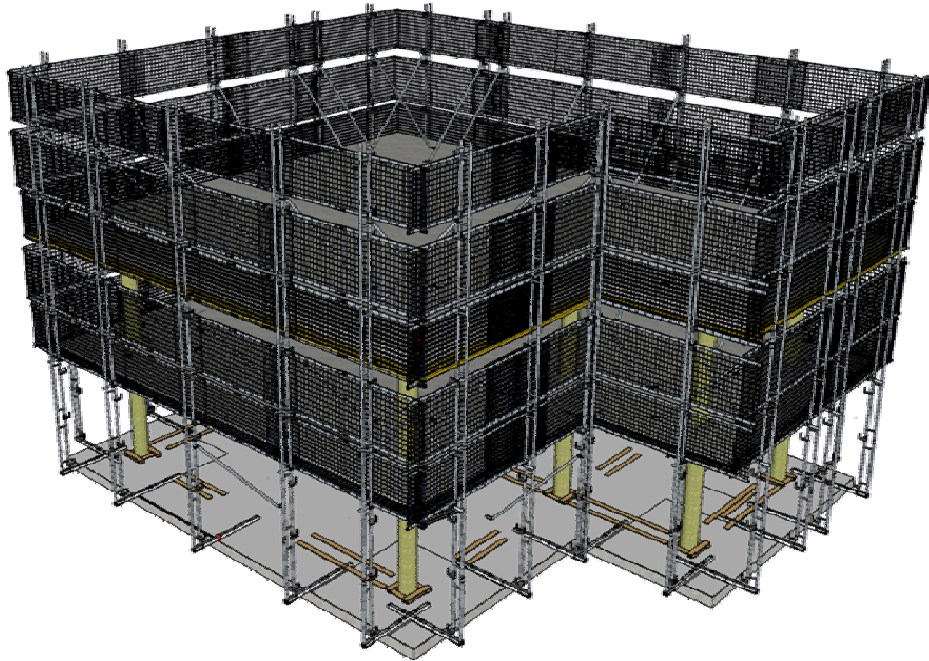

Fotografie sui cantieri
Construction site pictures



Componenti Components

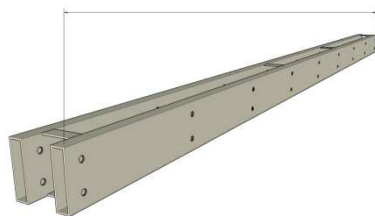

Bess supporto 1,00/2,00 ml - rif. D001

Bess support 1,00/2,00 ml - ref. D001

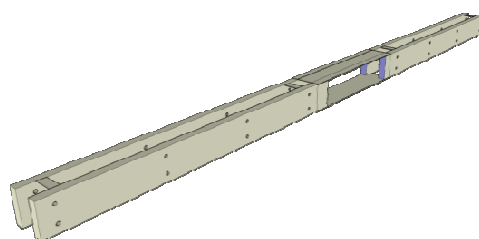

Bess supporto d'angolo - rif. DL001

Bess corner support - ref. DL001



Bess supporto montante - rif. D002

Bess upright support - ref. D002

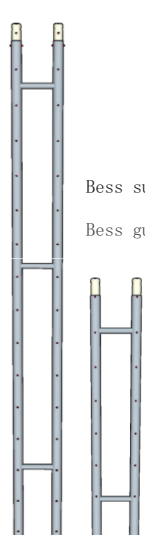

Bess supporto per correnti - rif. D004

Bess guardrail support - ref. D004

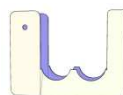

Bess spina - rif. D005

Bess pin - ref. D005

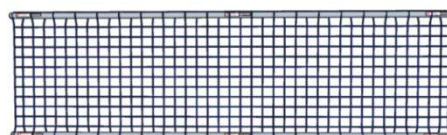

Bess rete e correnti - rif. D007-D008

Bess guardrail and net - ref. D007-D008

Bess montante verticale 1,50/3,00 ml - rif. D003

Bess vertical upright 1,50/3,00 ml - ref. D003

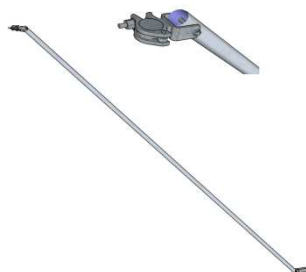

Bess asta tirante - rif. D006

Bess pulling rod - ref. D006

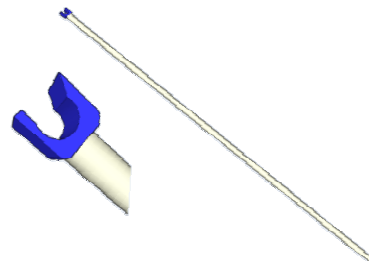

Bess asta d'installazione - rif. D009

Bess installation rod - ref. D009

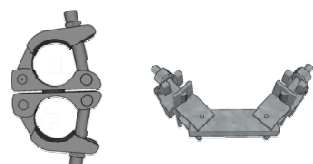

Bess doppio giunto - rif. D010

Bess double clamp - ref. D010



Bess supporto con giunto senza cassetto - rif. D011

Bess support without casting element - ref. D011



Bess cassetto - rif. D012

Bess casting element - ref. D012



Bess lamella - rif. D013

Bess reed - ref. D013

“Adjustable arm” system Sistema “Braccio regolabile”

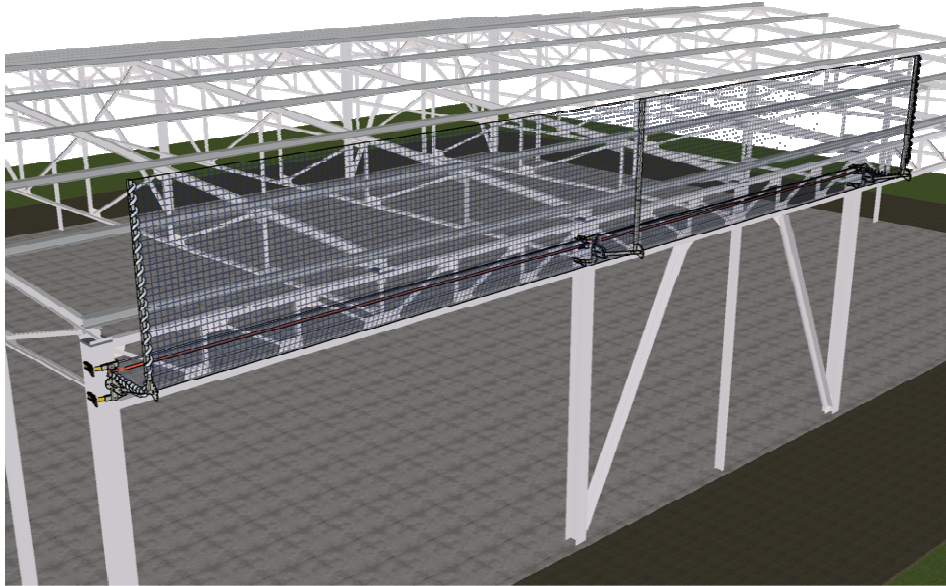

Fotografie sui cantieri Construction site pictures

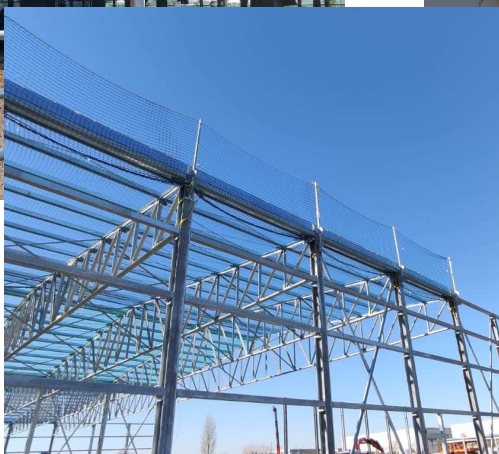

Componenti Components

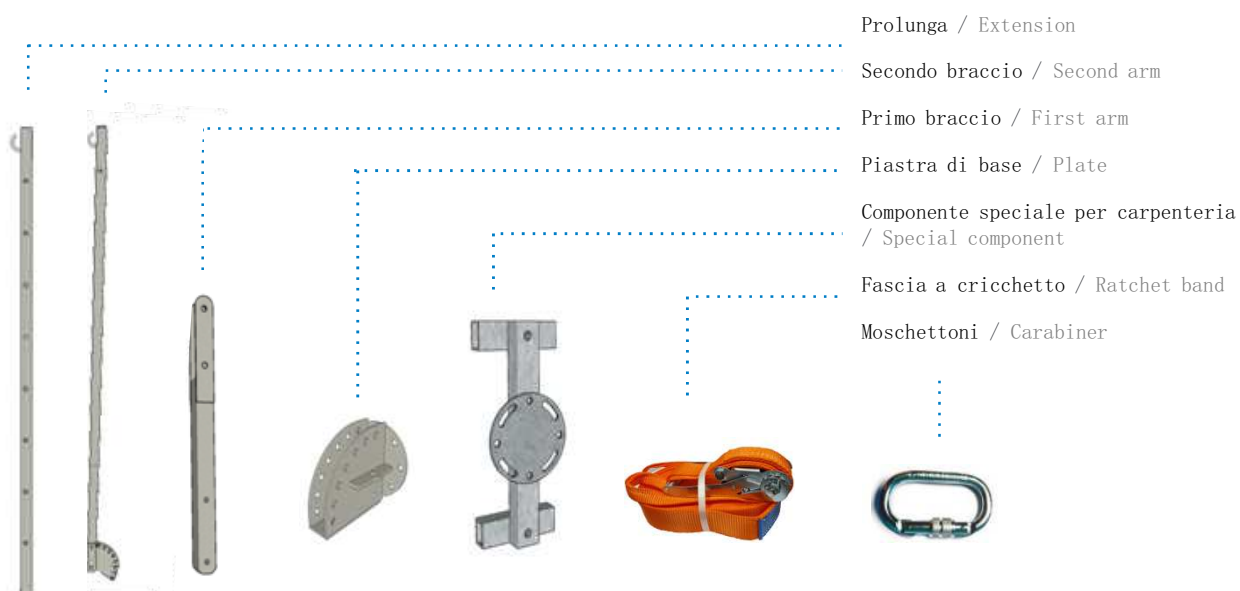

Technical Specifications / Caratteristiche tecniche

Code / Codice	Component / Componente	Length / Lunghezza (m)
BA - 2404	Componente speciale Special component	/
BA - 2405	Piastra di base Plate	/
BA - 2401	Primo braccio First arm	0,50 - 1,00
BA - 2403	Secondo braccio Second arm	2,00 - 2,50
BA - 2400	Prolunga Extension	2,00

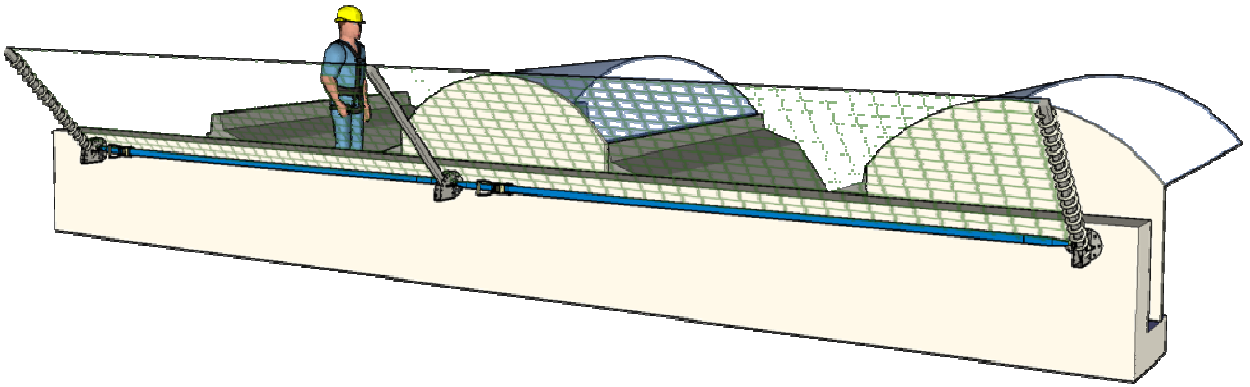

Fotografie sui cantieri
Construction site pictures



Componenti Components

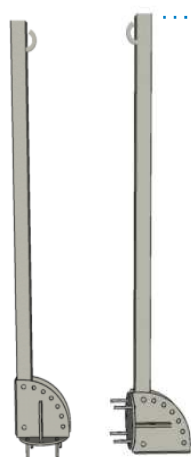

Primo braccio / First arm

Piastra di base / Plate

Fascia a cricchetto / Ratchet band

Technical Specifications / Caratteristiche tecniche

Code / Codice	Component / Componente	Length / Lunghezza (m)
BA - 2405	Piastra di base Plate	/
BA - 2401	Primo braccio First arm	0,50 - 1,00

Marking and traceability / Marcatura e tracciabilità

Reti brembo s.r.l.
by
Visonets

Spain :
Pol. Ind. Los Barrios C/ Los Alamos 9 03179
Las Heredades - Rojas
(Alicante) SPAIN. Tel:
(+34) 96 679 20 18
info@visonets.com

Italy :
Via Palma Jacopo I Vecchio, 157
24122 - Bergamo (BG)
info@retibrembo.com
www.retibrembo.com
Tel: (+39)035 63 15 134

**RETE SISTEMA
BRACCIO REGOLABILE
EN 1263,1 - V -A2 -Q 100**

DIMENSIONI VISOR
Nr° **0019** TIPO V 5x10

Minimum breaking strength test mesh 2200 N

Manufacture Date : 2017

1 / 2 / 3 / 4 / 5 / 6 / 7 / 8 / 9 / 10 / 11 / 12

First Revision : 2018

1 / 2 / 3 / 4 / 5 / 6 / 7 / 8 / 9 / 10 / 11 / 12

Reti brembo s.r.l.
by
Visonets

TRACEABILITY CODE : 140203

Reti brembo s.r.l.
by
Visonets

Via Brughiera 21
24030 Palazzago -Bg

Ref. BA-2405

Norma UNI-EN 1263-1
Norma UNI-EN 13374
CLASSE C
DATA DI COSTRUZIONE
20/05/2020

www.retibrembo.com

Debris + cover meshes

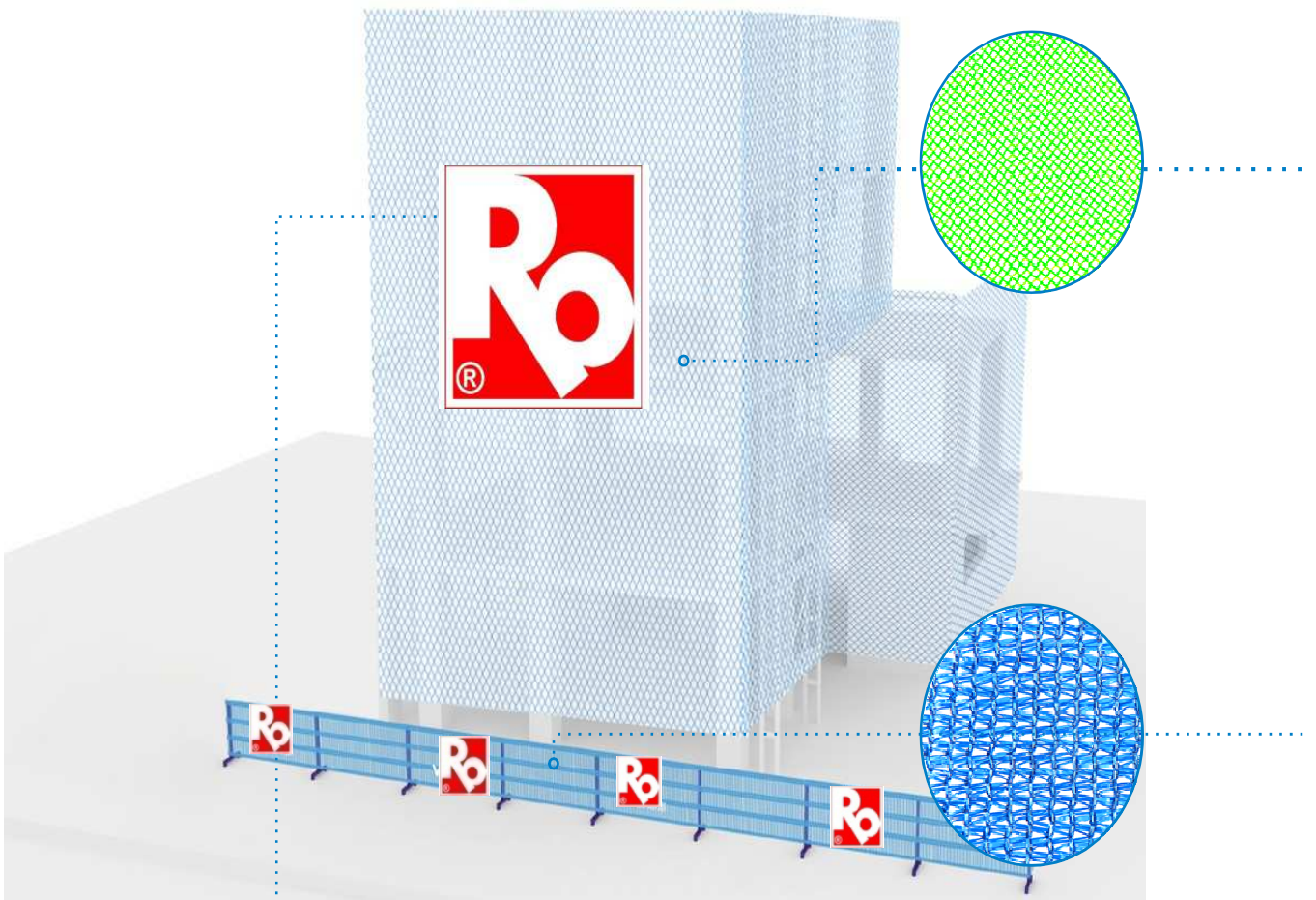

Maglia antidebriti e maglia oscurante



Costumised printed logo
Logo personalizzato stampato

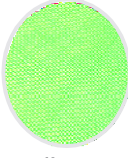
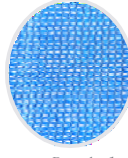

Debris mesh
Antidetriti

D / D

Type / Tipo		Weight / Peso (gr/m ²)	Colours / Colori		
 Non woven Liscia	 Raschel Intrecciata		30 / 85 / 75 / 130		

Option / Opzione
Flame retardant / Ritardante di fiamma (M¹)  Customised printed logo
Logo personalizzato

Cover mesh
Maglia
oscurante

Shade factor Percentuale d'oscuramento	Colours / Colori
75% / 95%	  

Customised printed logo
Logo personalizzato



Reti brembo s.r.l.

by
Visonets
Italia

Inspection pit nets

Rete per fosse d'ispezione

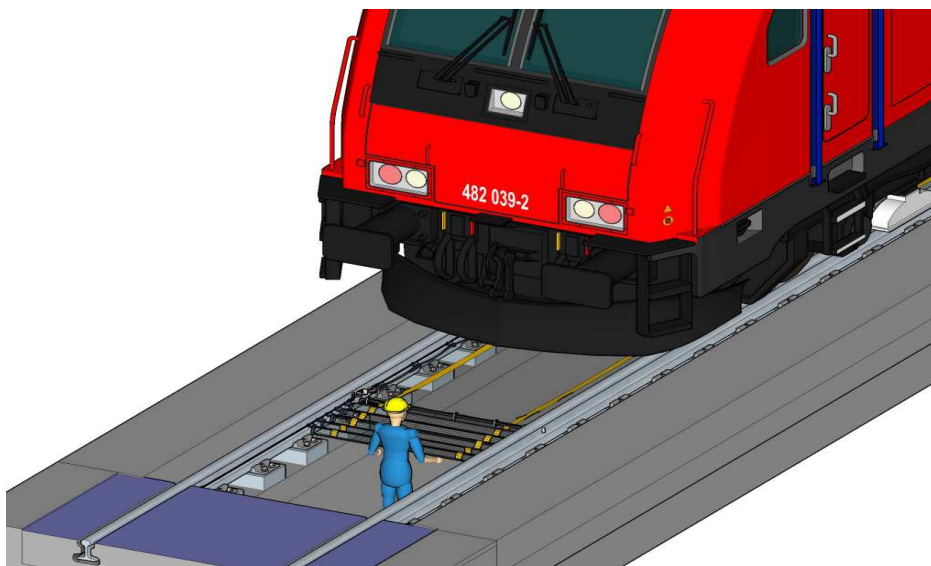

Accessori di fissaggio

Fixing accessories



Gancio + tassello
Pigtail anchor



Moschettone
Carabiner



Corda di cucitura
Coupling rope



Corda di legatura
Tie rope



Fune d'acciaio
Steel cable



Gancio in classe A
Class A anchor



Truck loading and unloading system

Sistema per il carico e scarico dei camion

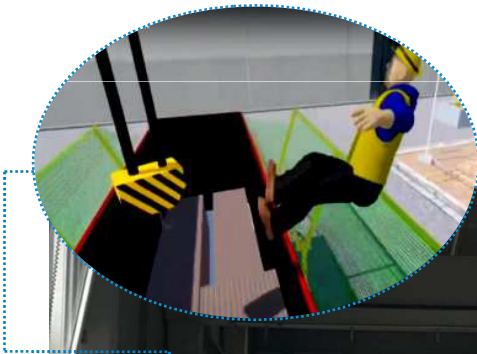

Componenti Components

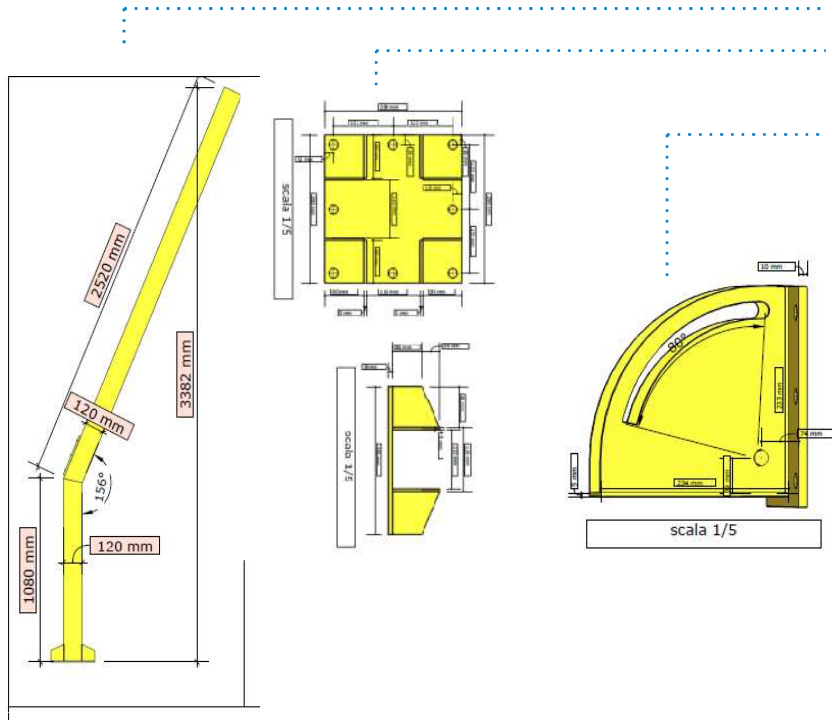

Montante fisso/Fixed post

Fori per ancoraggio pavimento/Holes for the floor attachment

Piastra per rotazione braccio/Plate for the arm rotation

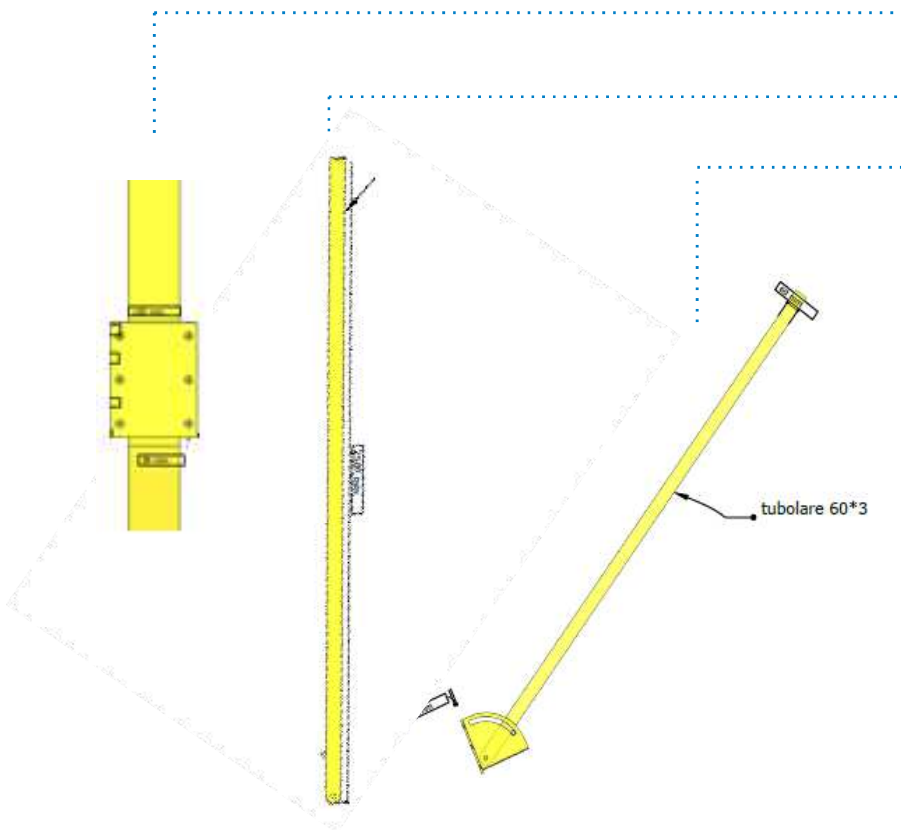

Piastra su montante fisso/Plate on fixed post

Braccio mobile/Adjustable rotatable arm

Tubolare/tube

Pistone pneumatico/Pneumatic piston



Nets for working platform beneath road bridges Rete per piani di lavoro sotto i ponti stradali

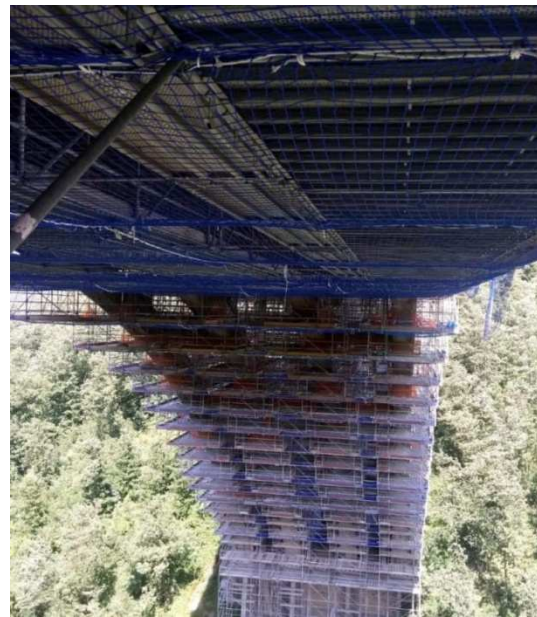
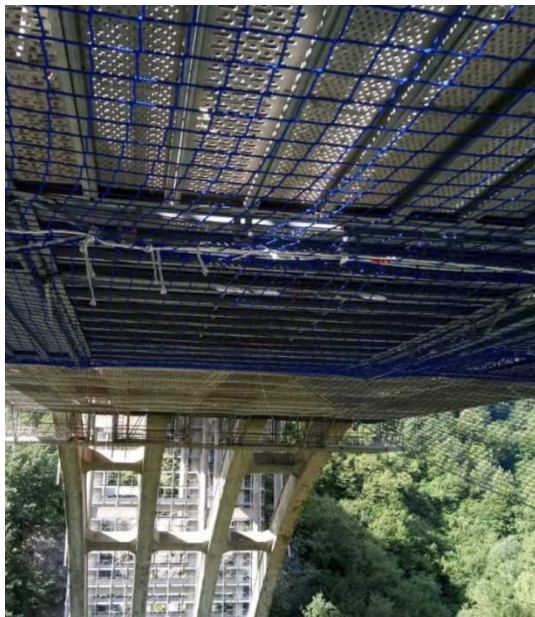
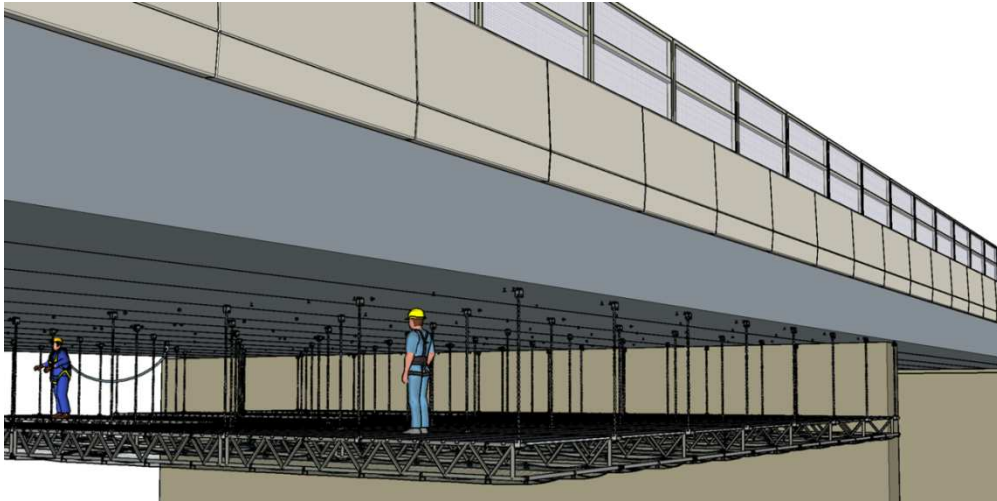

Accessori di fissaggio

Fixing accessories



Fascia a cricchetto

Ratchet belt



Moschettone

Carabiner



Corda di cucitura

Coupling rope



Corda di legatura

Tie rope

Wire mesh

Rete metallica per lucernari

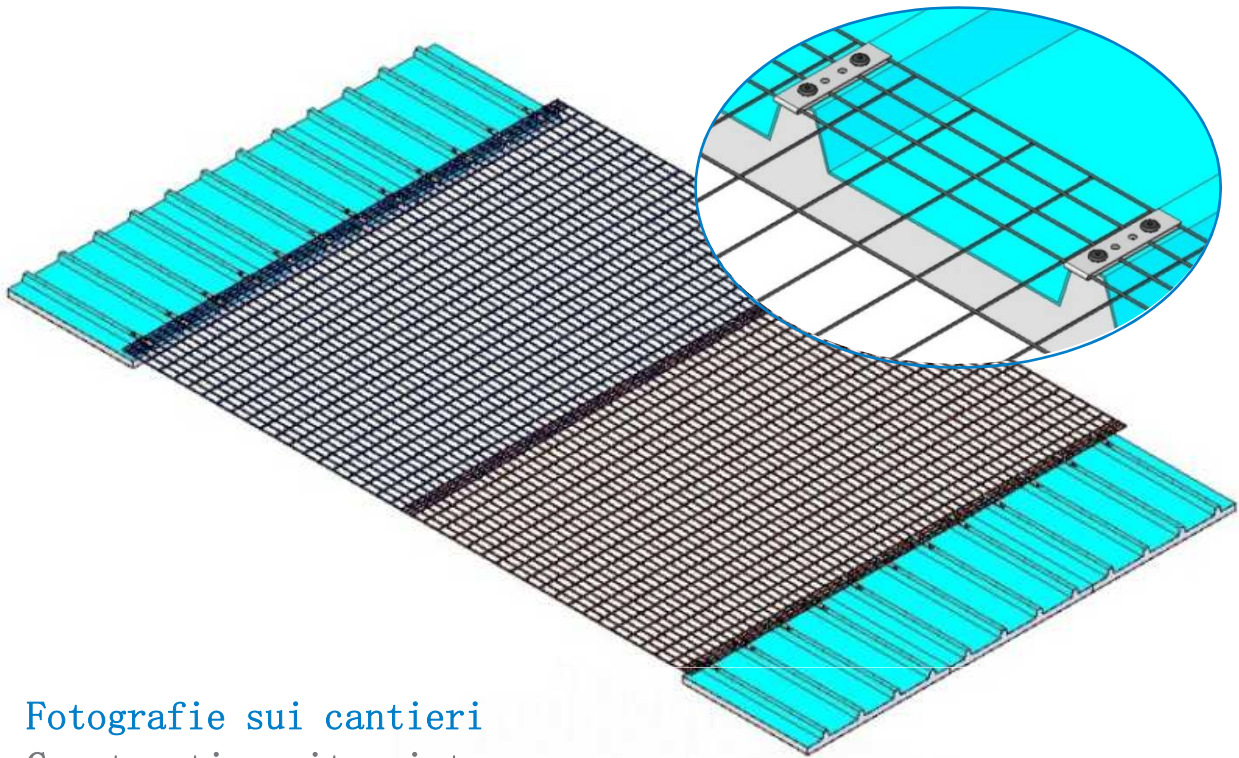

Fotografie sui cantieri

Construction site pictures

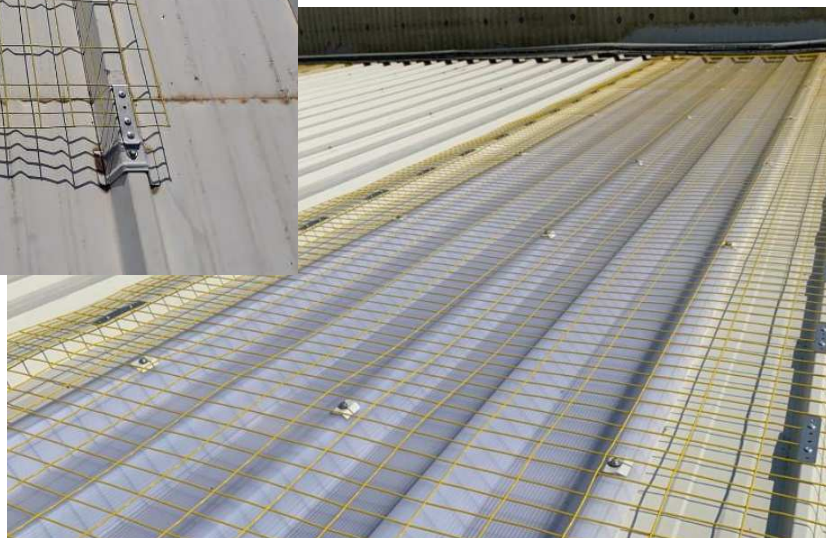



Reti brembo s.r.l.

by
Visonets
Italia

Systems
Sistemi

Type "M" skylight nets

Rete tessile definitiva per lucernari tipo "M"

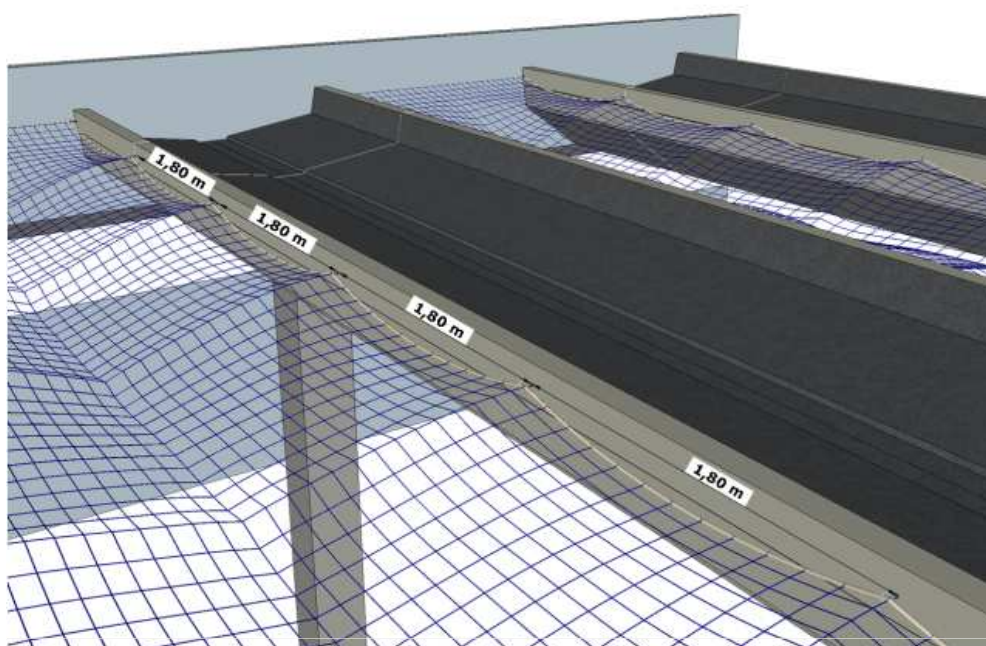

Accessori di fissaggio
Fixing accessories

Fotografie sui cantieri
Construction site pictures



Gancio + tassello
Pigtail anchor



Gancio da legno
Wood screw



Corda di legatura
Tie rope



Skylight nets with ratchet belt Rete per lucernari con fascia a cricchetto

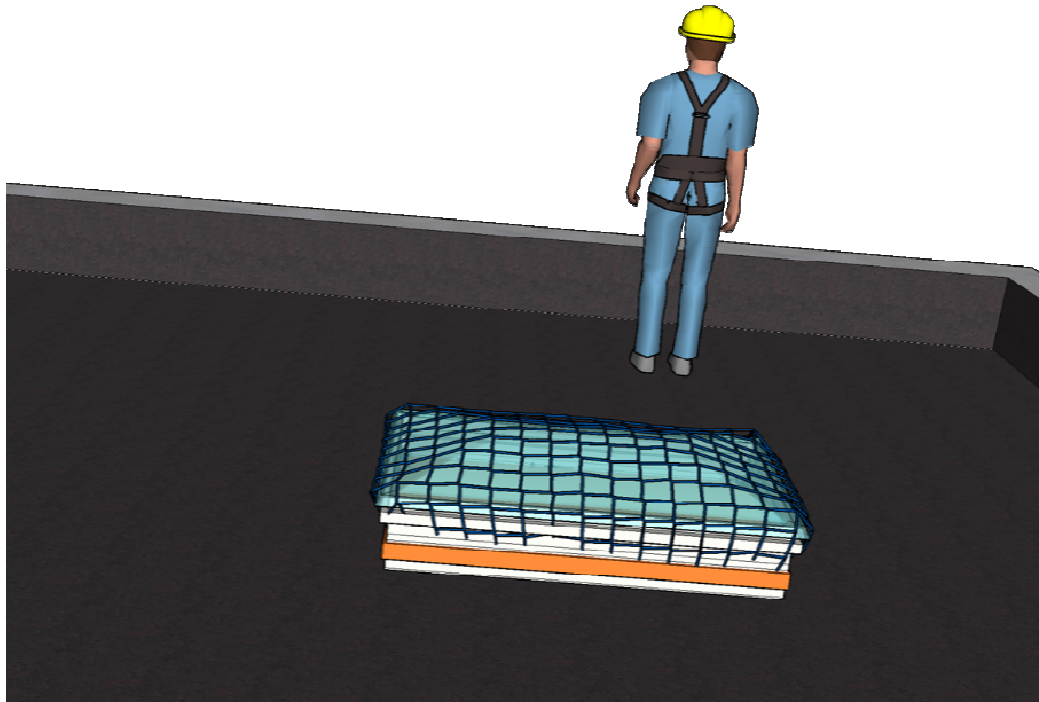

Accessori di fissaggio Fixing accessories



Gancio in classe A
Class A anchor



Fascia a cricchetto
Ratchet belt

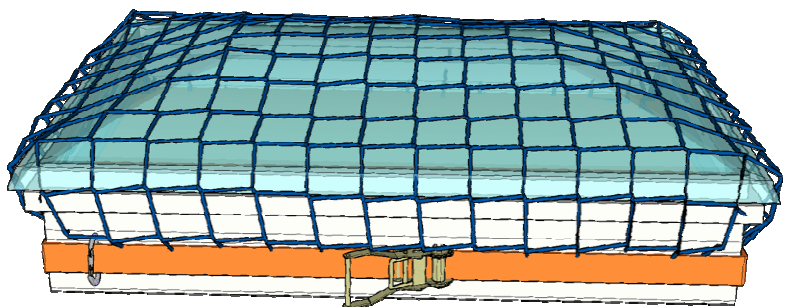



Reti brembo s.r.l.

by
Visonets
Italia



Anti-debris nets

Rete anticalnicacci

Systems
Sistemi



Fotografie sui cantieri

Construction site pictures



Accessori di fissaggio

Fixing accessories



Gancio + tassello
Pigtail anchor

Ancoraggio chimico
Chemical anchor

Corda di legatura
Tie rope

Corda di cucitura
Coupling rope

Moschettone
Carabiner

Fascia a cricchetto
Ratchet belt



Anti-bird nets Rete antivolatili

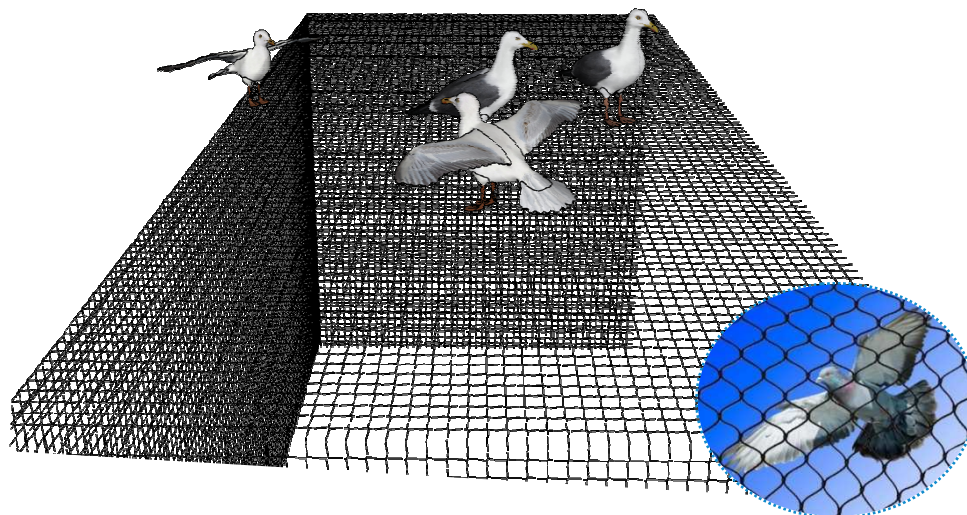

Fotografie sui cantieri Construction site pictures



Accessori di fissaggio Fixing accessories



Fune d'acciaio
Steel cable



Fascetta in plastica
Plastic ties



Clip metalliche
Metal C-rings



Reti brembo s.r.l.

by
Visonets
Italia

Systems
Sistemi

Soccer nets

Rete per porte da calcio



Su richiesta,
forniamo anche il
telaio metallico
If needed, we
also provide the
metal frame

Dimensioni disponibili

Available sizes

300 cm x 200 cm

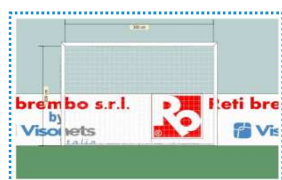

400 cm x 200 cm

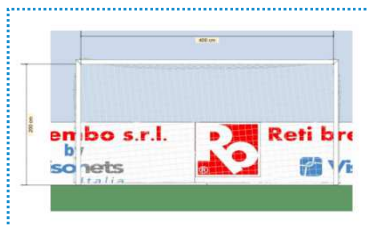

732 cm x 244 cm



Forniamo inoltre reti per la
recinzione dei campi da gioco
We also provide nets for the
fencing of the field

Fork nets

Rete per forca

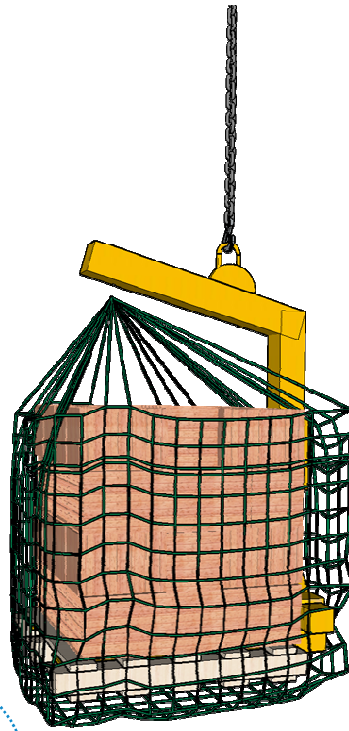

60 mm mesh net +
debris mesh
Rete maglia 60 mm
+ telo
antidetrimenti





Reti brembo s.r.l.

by
Visonets
Italia



Shelving nets





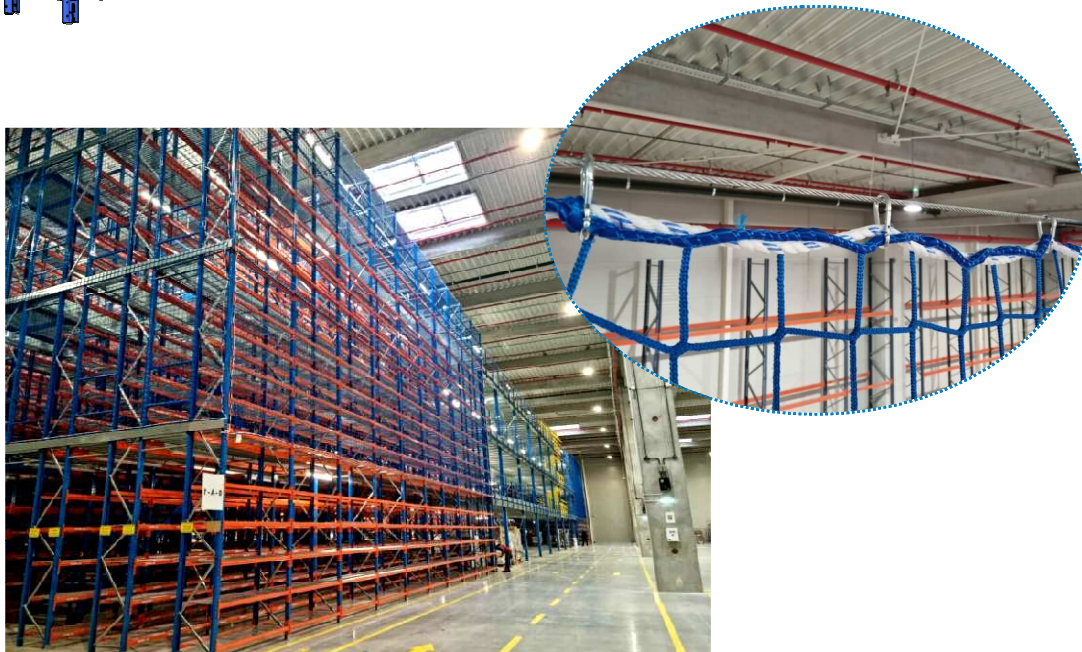
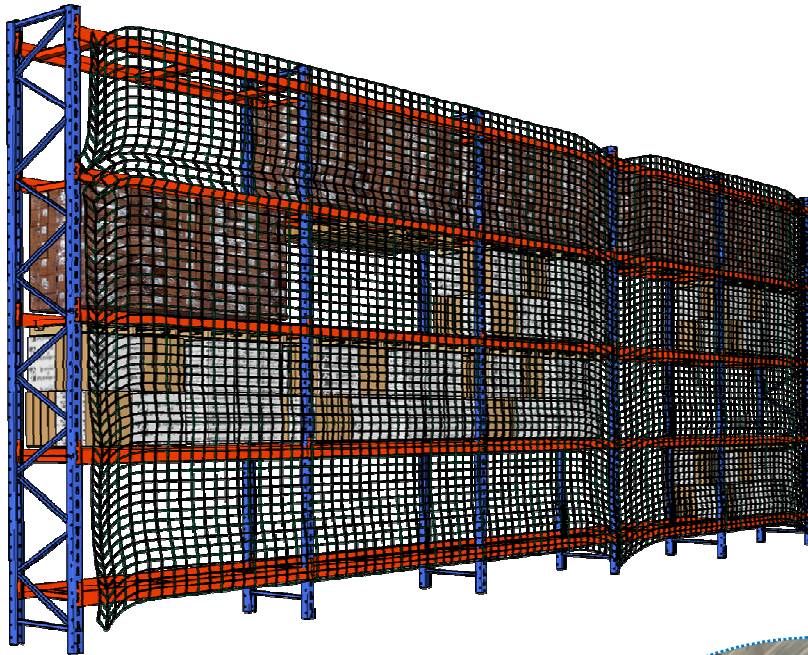



Systems
Sistemi

Rete per scaffali



Fixing accessories Accessori di fissaggio

Accessori di fissaggio			
ART.	Descrizione	pz	Immagine
9315	GANCIO A RICCIO AC M12 + TOP 18/92-160	1	
9316	GANCIO A RICCIO AC M12 + VHS 16/92-160	1	
9317	GANCIO A RICCIO AC M12 + VA M 15/65-140	1	
9318	GANCIO DELTA + ASR M8	1	
53224/934 2	GANCIO A RICCIO ACR M12 L=110	1	
53223	GANCIO A RICCIO ACR M12 L=148	1	
99593	VA 12X50 FILETTO INTERNO 18mm	1	
99594	VA F CE 15/M12X50 BATTUTA SVASATA	1	
9322	GANCIO A RICCIO AC LEGNO 10/45-160	1	
91153F	GOLFARE ZC. FORG. OVALE FEMM. M12	1	

Accessori di fissaggio			
ART.	Descrizione	pz	Immagine
998	OCCHIOLO ZINCATO STAMP. FILET. M12	1	
804	BARRA FIL. ZINC. FE37 M12X90	1	
114080	OCCHIOLO CEMENTO ARMATO	1	
4649	ANCORANTE PASSANTE CON FILETTO ESTERNO VE 7 CE 12/10-90	1	
299	PERNO VA 12 A PERCUSSIONE	1	
1120	ANCOR. CHIM. CV VSF PRO 400 CE	1	
1101	PISTOLA COASSIALE ACCIAIO 380/410	1	
1072	POMPETTA MANUALE FORI 225 mm	1	
MOSC005	MOSCHETTONI	1	
GSP06	GANCIO PER PUNTELLO	1	
GAN A1	GANCIO IN CLASSE A1	1	





Reti brembo s.r.l.

by
Visonets
Italia

Accessories

Accessori

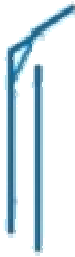
Corde di attacco e cucitura certificate e fasce a cricchetto/di partenza			
ART.	Descrizione	pz	Immagine
CRD0150	CORDA DI LEGATURA 100 ML Ø 10 MM	1	
CRD0075	CORDA DI CUCITURA 100 ML Ø 6 MM	1	
CRD0200	CORDA DI LEGATURA 100 ML Ø 12 MM	1	
FSAC001	FASCIA A CRICCHETTO 10 ML/50 MM	1	
FSAC003	FASCIA A CRICCHETTO 15 ML/50 MM	1	
FSAC005	FASCIA A CRICCHETTO 20 ML/50 MM	1	
FSAC004	FASCIA 4 ML DOPPIA ASOLA	1	
FSAC007	FASCIA A CRICCHETTO 8 ML/50 MM	1	
FPRU008	FASCETTA CON FIBBIA METALLICA 0,50 ML	1	
BA-2420	FASCIA PER BRACCIO REGOLABILE	1	
CRD0075/C	AGO PER CUCITURA	1	

Strutture T-V-CAMION		
ART.	Prezzo €	Immagine
SISTEMA T	A PREVENTIVO	
SISTEMA V	A PREVENTIVO	
CARICO CAMION	A PREVENTIVO	



Reti brembo s.r.l.

by
Visonets
Italia

Reti Brembo by Visor Nets Catalogue

SERVICES

SERVIZI





Reti brembo s.r.l.

by
Visonets
Italia

Services
Servizi



Bespoke solutions
Soluzioni personalizzate
Formation
Formazione
Distribution
Distribuzione





BESPOKE SOLUTIONS

SOLUZIONI PERSONALIZZATE

For special projects where none of our safety nets and/or passive collective systems are strictly applicable, Reti Brembo engineering team can assist you.

How do we do?

1st. Particular case study by our engineering department. In this step we are able to define if is possible to adjust any of our systems, creation of a specific another one or definitely not, in the latter case we will not proceed to the next step.

2nd. Submitting an offer to the customer with the suitable solution in different stages:

1. 3D design, including a calculation note and an installation guide.
2. Comprehensive offer on the whole elements, including nets, steel structures and different hardware for the installation.
3. Prototype test on external laboratory.
4. Training on site.

Per progetti particolari in cui nessuna delle nostre reti di sicurezza e/o sistemi passivi collettivi sono applicabili, il team di ingegneri di Reti Brembo può aiutarti.

Come lo facciamo?

1° Studio del caso particolare da parte del nostro dipartimento di ingegneria. In questo passaggio siamo in grado di definire se è compatibile uno qualsiasi dei nostri sistemi, se è possibile la creazione di un altro sistema specifico o se invece non è fattibile. In quest'ultimo caso non procederemo al passaggio successivo.

2° Presentazione di una offerta al cliente con la soluzione adeguata in vari punti:

1. Progettazione 3D, compresa una nota di calcolo e una guida all'installazione.
2. Offerta integrale per tutti gli elementi, comprese le reti, le strutture in acciaio e i vari raccordi per l'installazione.
3. Prova del prototipo in un laboratorio esterno.
4. Formazione in loco.

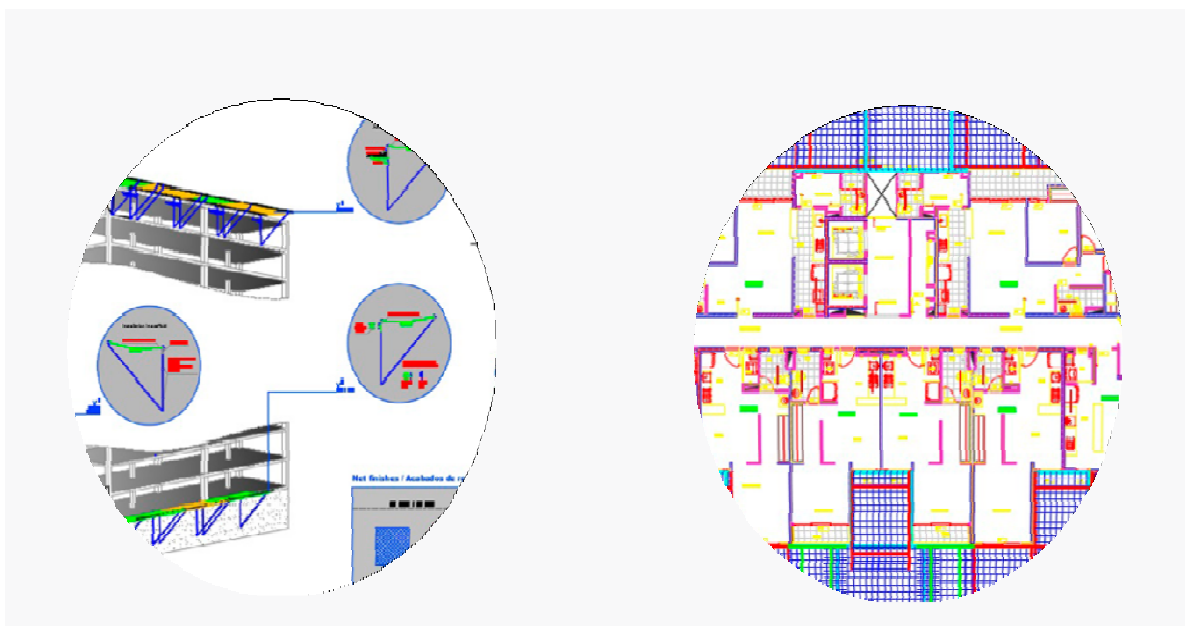



Implementation of cellular networks and cellular collection networks
and their maintenance plans according to the 1998-1 and the 1998-2

ICT FOR EXXON MOBILE EGYPT



Reti brembo s.r.l.

www.retibrembo.com

FORMATION FORMAZIONE

.....

We offer training and advice services worldwide, both in Spanish and Italian.

We have available specific courses for systems Reti Brembo-V, Reti Brembo-T and Reti Brembo-S, as well as a catalogue of custom training courses.

Offriamo servizi di consulenza e formazione in ogni angolo del mondo, sia in inglese che in spagnolo e italiano.

Facciamo corsi in sistemi specifici Reti Brembo-V, Reti Brembo-T e Reti Brembo-S, oltre a un catalogo di formazione personalizzato.



Reti brembo s.r.l.

by
Visonets
Italia

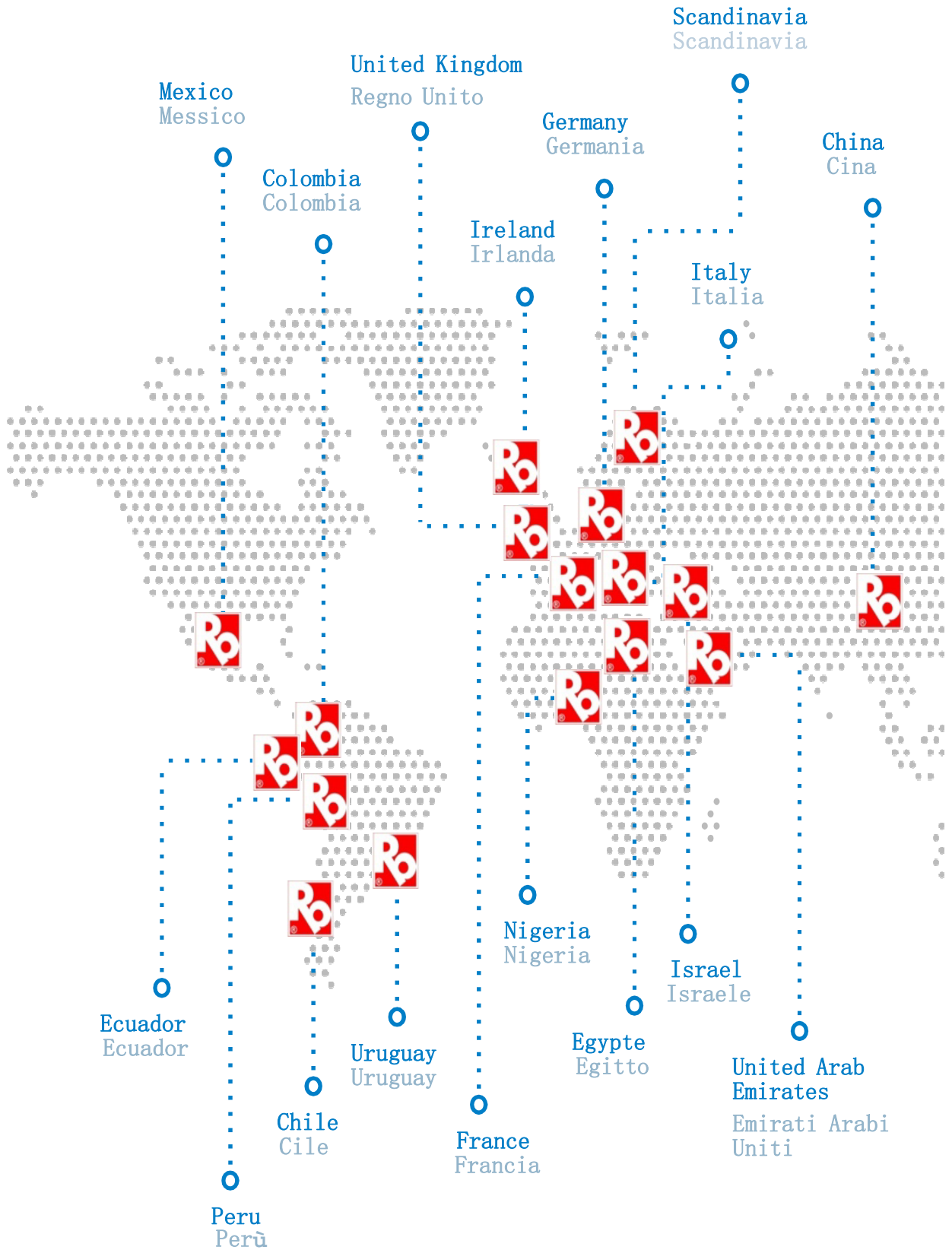

DISTRIBUTION DISTRIBUZIONE

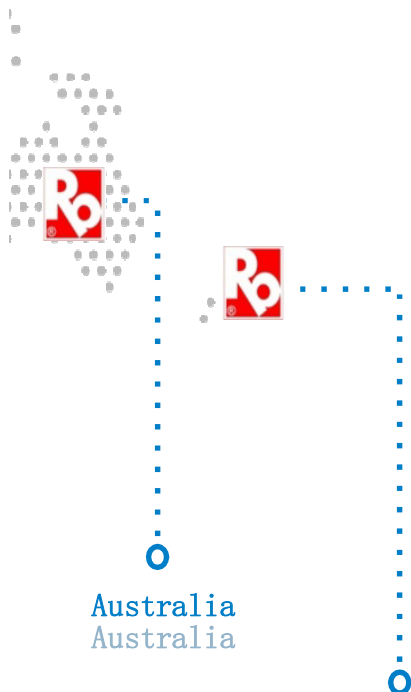
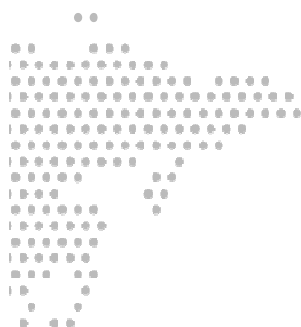

Australia
Australia

New Zeland
Nuova Zelanda

.....

We have distributors in different countries around the world. Contact us to find if there is a Reti Brembo distributor in your country.

Reti Brembo does not install nets, but has agreements with numerous authorised installers. Contact us for more details.

Abbiamo società di distribuzione in vari paesi del mondo. Contattateci per scoprire se esiste un distributore Reti Brembo nel vostro paese.

Reti Brembo non installa reti, ma ha accordi con numerose società di installazione autorizzate. Contattaci per maggiori informazioni.



Reti brembo s.r.l.

by
Visonets
Italia



More than nets.





Reti brembo s.r.l.



Reti Brembo s.r.l.
Viale Vittorio Emanuele II, 43
24121 Bergamo
035 6315134
info@retibrembo.com
c.f./p.iva : 03775260163

